

Altivar 71 Plus-LH

Low Harmonic Drive Systems 75 ... 2000 kW



Altivar 71 Plus
low harmonic

Important information

The information provided in this documentation contains general descriptions and/or technical characteristics of the performance of the products contained herein. This documentation is not intended as a substitute for and is not to be used for determining suitability or reliability of these products for specific user applications. It is the duty of any such user or integrator to perform the appropriate and complete risk analysis, evaluation and testing of the products with respect to the relevant specific application or use thereof. Neither Schneider Electric nor any of its affiliates or subsidiaries shall be responsible or liable for misuse of the information contained herein. If you have any suggestions for improvements or amendments or have found errors in this publication, please notify us.

No part of this document may be reproduced in any form or by any means, electronic or mechanical, including photocopying, without express written permission of Schneider Electric.

All pertinent state, regional, and local safety regulations must be observed when installing and using this product. For reasons of safety and to help ensure compliance with documented system data, only the manufacturer should perform repairs to components.

When devices are used for applications with technical safety requirements, the relevant instructions must be followed.

Failure to use Schneider Electric software or approved software with our hardware products may result in injury, harm, or improper operating results.

Failure to observe this information can result in injury or equipment damage.

© 2013 Schneider Electric. All rights reserved.

Altivar 71 Plus-LH

Configuration guide for 75...2000 kW



▪ Drive Systems.....	1
□ Content	1
□ Overview	2
□ Enclosure design	6
□ Purchase order	9
▪ Safety informations	13
□ Important information	13
▪ General specification.....	15
□ Quality.....	15
□ Mains conditions.....	18
□ Protection of the plant	20
▪ Altivar 71EX●●●●●N4H	23
□ Description	23
□ Specification	25
□ Connection.....	41
□ Options	45
▪ ATV71EX●●●●●YH.....	49
□ Description	49
□ Specification	51
□ Connection.....	58
□ Options	62
▪ Wiring and connection	65
□ Wiring diagram.....	65
▪ Options	69
□ Cubicle options.....	69
□ Cubicle options (depending on power)	85
□ Width of the cubicle.....	94



Type of drive	Pumps and fans (industrial environment)	Complex machines
		
Type	Altivar 61	Altivar 71
Power range	0.37...800 kW	0.37...630 kW
Voltage ranges	1 AC 200...240 V (0.37...5.5 kW) 3 AC 200...240 V (0.75...90 kW) 3 AC 380...480 V (0.75...630 kW) 3 AC 500...690 V (2.2...800 kW)	1 AC 200...240 V (0.37...5.5 kW) 3 AC 200...240 V (0.37...75 kW) 3 AC 380...480 V (0.75...500 kW) 3 AC 500...690 V (1.5...630 kW)
Output frequency	0.1...500 Hz for the whole power range 0.1...1000 Hz up to 37 kW	0.1...500 Hz for the whole power range 0.1...1000 Hz up to 37 kW
Control method	V/f characteristic (2 or 5 points), vector-oriented flux control without feedback, energy saving system	V/f characteristic (2 or 5 points), vector-oriented flux control with/without encoder, ENA system
Interfaces	Removable operating panel, extensible terminals, programmable card "Drive-Controller", multi-pump card, Profibus DP, CANopen, Ethernet TCP/IP, Fipio, Modbus Plus, INTERBUS, Modbus/Uni-Telway, DeviceNet, LonWorks, METASYS N2, APOGEE FLN, BACnet	Removable operating panel, extensible terminals, programmable card "Drive-Controller", multi-pump card, Profibus DP, CANopen, Ethernet TCP/IP, Fipio, Modbus Plus, INTERBUS, Modbus/Uni-Telway, DeviceNet
Protection degree	Built-in units: IP00 / IP20 Wall-mounting devices: IP31	Built-in units: IP00 / IP20 Wall-mounting devices: IP31
Further reading	Information about project planning and order can be found in the product catalogue "Variable speed drives for asynchronous motors Altivar 61" and on www.schneider-electric.com .	Information about project planning and order can be found in the product catalogue "Variable speed drives for asynchronous motors Altivar 71" and on www.schneider-electric.com .

Type of drive	Water-cooled frequency inverter	Energy recovery / sinusoidal mains current
----------------------	--	---



Type	Altivar 61Q / Altivar 71Q	Altivar AFE
Power range	90...800 kW	120...860 kW
Voltage ranges	3 AC 380...480 V 3 AC 500...690 V	3 AC 380...480 V 3 AC 500...690 V
Output frequency	0.1...500 Hz for the whole power range	—
Control method	V/f characteristic (2 or 5 points), vector-oriented flux control with/without encoder, ENA system	—
Interfaces	Removable operating panel, extensible terminals, programmable card "Drive-Controller", multi- pump card, Profibus DP, CANopen, Ethernet TCP/IP, Fipio, Modbus Plus, INTERBUS, Modbus/Uni-Telway, DeviceNet,...	Removable operating panel, extensible terminals, Modbus, CANopen, other fieldbuses by means of option card "Communication bridge"
Protection degree	Built-in units: IP00 / IP20	Built-in units: IP00 / IP20
Further reading	Information about project planning and order can be found in the product catalogue "Variable speed drives for asynchronous motors Altivar 61 or Altivar 71" and on www.schneider-electric.com .	Information about project planning and order can be found in the product catalogue "Variable speed drives for asynchronous motors Altivar 61 or Altivar 71" and on www.schneider-electric.com .

Type of drive	Pumps and fans	Drives with high performance in industry, machine building and automation																
																		
Type	ATV 61 Plus	ATV 71 Plus																
Brief description	Altivar Drive Systems with increased protection degree, alternatively in the standard design, with additionally installed options or as a customized solution	Altivar Drive Systems with increased protection degree, alternatively in the standard design, with additionally installed options or as a customized solution																
Power ranges	<table border="1"> <tr> <td>ATV61ES5●●●N4</td> <td>90...630 kW</td> </tr> <tr> <td>ATV61EX●●●●●N4</td> <td>90...1400 kW</td> </tr> <tr> <td>ATV61EX●●●●●N</td> <td>90...1800 kW</td> </tr> <tr> <td>ATV61EX●●●●●Y</td> <td>110...2400 kW</td> </tr> </table>	ATV61ES5●●●N4	90...630 kW	ATV61EX●●●●●N4	90...1400 kW	ATV61EX●●●●●N	90...1800 kW	ATV61EX●●●●●Y	110...2400 kW	<table border="1"> <tr> <td>ATV71ES5●●●N4</td> <td>90...500 kW</td> </tr> <tr> <td>ATV71EX●●●●●N4</td> <td>90...1300 kW</td> </tr> <tr> <td>ATV71EX●●●●●N</td> <td>90...1500 kW</td> </tr> <tr> <td>ATV71EX●●●●●Y</td> <td>110...2000 kW</td> </tr> </table>	ATV71ES5●●●N4	90...500 kW	ATV71EX●●●●●N4	90...1300 kW	ATV71EX●●●●●N	90...1500 kW	ATV71EX●●●●●Y	110...2000 kW
ATV61ES5●●●N4	90...630 kW																	
ATV61EX●●●●●N4	90...1400 kW																	
ATV61EX●●●●●N	90...1800 kW																	
ATV61EX●●●●●Y	110...2400 kW																	
ATV71ES5●●●N4	90...500 kW																	
ATV71EX●●●●●N4	90...1300 kW																	
ATV71EX●●●●●N	90...1500 kW																	
ATV71EX●●●●●Y	110...2000 kW																	
Voltage ranges	<table border="1"> <tr> <td>ATV61ES5●●●N4</td> <td>380...415 V</td> </tr> <tr> <td>ATV61EX●●●●●N4</td> <td>400 (380, 415) V</td> </tr> <tr> <td>ATV61EX●●●●●N</td> <td>500 (525) V</td> </tr> <tr> <td>ATV61EX●●●●●Y</td> <td>690 V</td> </tr> </table> <p>Other voltages are available on request</p>	ATV61ES5●●●N4	380...415 V	ATV61EX●●●●●N4	400 (380, 415) V	ATV61EX●●●●●N	500 (525) V	ATV61EX●●●●●Y	690 V	<table border="1"> <tr> <td>ATV71ES5●●●N4</td> <td>380...415 V</td> </tr> <tr> <td>ATV71EX●●●●●N4</td> <td>400 (380, 415) V</td> </tr> <tr> <td>ATV71EX●●●●●N</td> <td>500 (525) V</td> </tr> <tr> <td>ATV71EX●●●●●Y</td> <td>690 V</td> </tr> </table> <p>Other voltages are available on request</p>	ATV71ES5●●●N4	380...415 V	ATV71EX●●●●●N4	400 (380, 415) V	ATV71EX●●●●●N	500 (525) V	ATV71EX●●●●●Y	690 V
ATV61ES5●●●N4	380...415 V																	
ATV61EX●●●●●N4	400 (380, 415) V																	
ATV61EX●●●●●N	500 (525) V																	
ATV61EX●●●●●Y	690 V																	
ATV71ES5●●●N4	380...415 V																	
ATV71EX●●●●●N4	400 (380, 415) V																	
ATV71EX●●●●●N	500 (525) V																	
ATV71EX●●●●●Y	690 V																	
Output frequency	0.1 ... 500 Hz	0.1 ... 500 Hz																
Control method	V/f characteristic (2 or 5 points), vector-oriented flux control without feedback, energy saving system	V/f characteristic (2 or 5 points), vector-oriented flux control with/without encoder, ENA system																
Interfaces	Operating panel in the enclosure door with a transparent cover, control terminals alternatively directly in the inverter or in the enclosure, control terminals can be extended, fieldbus connection via Modbus or CANopen	Operating panel in the enclosure door with a transparent cover, control terminals alternatively directly in the inverter or in the enclosure, control terminals can be extended, fieldbus connection via Modbus or CANopen																
Protection degree	IP23 design of the enclosure IP54 design of the enclosure IP54 design of the enclosure with separated air flow	IP23 design of the enclosure IP54 design of the enclosure IP54 design of the enclosure with separated air flow																
Further reading	Information about project planning and order can be found in the "Configuration guide Altivar 61 Plus" and on www.schneider-electric.com .	Information about project planning and order can be found in the "Configuration guide Altivar 71 Plus" and on www.schneider-electric.com .																

<p>Type of drive</p>	<p>Low Harmonic Drive for pumps and fans</p>	<p>Low Harmonic Drive for drives with high performance in industry, machine building and automation</p>								
										
<p>Type</p>	<p>ATV 61 Plus-LH</p>	<p>ATV 71 Plus-LH</p>								
<p>Brief description</p>	<p>Altivar Low Harmonic Drive Systems with increased protection degree, alternatively in the standard design, with additionally installed options or as a customized solution</p>	<p>Altivar Low Harmonic Drive Systems for power regeneration to the supplying mains, alternatively in the standard design, with additionally installed options or as a customized solution</p>								
<p>Power ranges</p>	<table border="1"> <tr> <td>ATV61EXC●●●N4H</td> <td>55...630 kW</td> </tr> <tr> <td>ATV61EXA●●●YH</td> <td>800...2400 kW</td> </tr> </table>	ATV61EXC●●●N4H	55...630 kW	ATV61EXA●●●YH	800...2400 kW	<table border="1"> <tr> <td>ATV71EXC●●●N4H</td> <td>75...500 kW</td> </tr> <tr> <td>ATV71EXA●●●YH</td> <td>630...2000 kW</td> </tr> </table>	ATV71EXC●●●N4H	75...500 kW	ATV71EXA●●●YH	630...2000 kW
ATV61EXC●●●N4H	55...630 kW									
ATV61EXA●●●YH	800...2400 kW									
ATV71EXC●●●N4H	75...500 kW									
ATV71EXA●●●YH	630...2000 kW									
<p>Voltage ranges</p>	<table border="1"> <tr> <td>ATV61EXC●●●N4H</td> <td>400 (380, 415) V</td> </tr> <tr> <td>ATV61EXA●●●YH</td> <td>690 V</td> </tr> </table>	ATV61EXC●●●N4H	400 (380, 415) V	ATV61EXA●●●YH	690 V	<table border="1"> <tr> <td>ATV71EXC●●●N4H</td> <td>400 (380, 415) V</td> </tr> <tr> <td>ATV71EXA●●●YH</td> <td>690 V</td> </tr> </table>	ATV71EXC●●●N4H	400 (380, 415) V	ATV71EXA●●●YH	690 V
ATV61EXC●●●N4H	400 (380, 415) V									
ATV61EXA●●●YH	690 V									
ATV71EXC●●●N4H	400 (380, 415) V									
ATV71EXA●●●YH	690 V									
<p>Output frequency</p>	<p>0.1 ... 500 Hz</p>	<p>0.1 ... 500 Hz</p>								
<p>Control method</p>	<p>V/f characteristic (2 or 5 points), vector-oriented flux control without feedback, energy saving system</p>	<p>V/f characteristic (2 or 5 points), vector-oriented flux control with/without encoder, ENA system</p>								
<p>Interfaces</p>	<p>Operating panel in the enclosure door with a transparent cover, control terminals alternatively directly in the inverter or in the enclosure, control terminals can be extended, fieldbus connection via Modbus or CANopen</p>	<p>Operating panel in the enclosure door with a transparent cover, control terminals alternatively directly in the inverter or in the enclosure, control terminals can be extended, fieldbus connection via Modbus or CANopen</p>								
<p>Protection degree</p>	<p>IP23 design of the enclosure IP54 design of the enclosure</p>	<p>IP23 design of the enclosure IP54 design of the enclosure</p>								
<p>Further reading</p>	<p>Information about project planning and order can be found in this document.</p>	<p>Information about project planning and order can be found in this document.</p>								

Altivar Low Harmonic Drive Systems

The Altivar 71 Plus Low Harmonic Drive is used when drives should contain mains harmonics particularly low.

State-of-the-art components, a new control concept as well as a top-quality filter module reduce the total current distortion factor THD(i) to a value less than 5 %.

During the development of the enclosure system special attention was paid to the "simplicity" of installation and during operation. The result is an enclosure ready to connect which fulfils the high requirements for the total current distortion factor THD(i). Consequently, the Altivar 71 Plus-LH is a topical response to energy dissipation and mains pollution.

The modular construction makes it possible to adapt the Altivar 71 Plus-LH to the individual requests. This makes the planning easy and helps to ensure a quick installation and commissioning of the drive.

Basic equipment of the Altivar 71 Plus-LH

This range includes an enclosure which is ready to connect and already pre-set. The basic equipment contains a frequency inverter, an Active Infeed Converter, a Clean Power filter (EMC filter, line contactor and charging circuit), a line filter choke, a main switch, semiconductor fuses and terminals for comfortable connection.

The design is based on the standard enclosure system Spacial SF with the operating panel built-in into the door.

The control is located on a spacious swing frame. That ensures compact dimensions, nevertheless it is enough space for additional extensions and accessibility in case of maintenance.

Device features**Enclosure system**

The Spacial SF enclosure system with additional internal reinforcement elements and slide bars for easy installation and removal of the inverter devices and other power components can be added to any existing enclosure systems.

Operation / parameterization

For comfortable control, clear parameterization and fast diagnosis, the operating panel is installed in the enclosure door at an ideal height. A transparent protective cover and an adjustable locking code helps to prevent the unintended parameter adjustments.

Displays on the enclosure

Permanently present status displays that show the actual device state at any time.

Up to 5 analog actual values can be parameterized for the display and thus provide information on the relevant drive data at any time.

Connection

Generous space is provided to connect the power cables. The extensibility and accessibility of the control terminals is also taken into consideration.

Extensibility

The Altivar 71 Plus-LH enclosures are equipped with a large, swivelling control panel which permits subsequent extensions.

Enclosure design 400 V**General technical data**

Mains voltage	400 (380 ... 415) V $\pm 10\%$, 50/60 Hz $\pm 5\%$ for TT, TN-C, TN-S or IT networks
Maximum current	150 % for 60 s per 10 minutes, 165 % for 2 seconds
Output voltage	0 ... 110 % of line voltage
Ambient temperature	0 ... +40°C, -10°C ... +50°C with enclosure heating and derating possible
Standards	CE, C-Tick, Gost, ATEX
General design	Enclosure system Spacial SF in RAL 7035 Controls in the enclosure door with additional protective cover, Cable entry from below, enclosure depth 605 mm (642 mm incl. door handle)
Interfaces	Control terminals directly on the inverter or alternatively in the enclosure, control terminals can be extended, fieldbus connection via Modbus or CANopen

ATV71EXC2●●●N4H**ATV71EXC5●●●N4H**

IP23CV Compact version	Air flow through grid in enclosure door and mounted air guidance hood, Enclosure height of 2157 mm
IP54CV Compact version	Air flow through filter mats in enclosure door and a top mounted fan, Enclosure height of 2237 mm
Standard equipment	Frequency inverter ATV71, Active Infeed Converter, Clean Power Filter (EMC filter, line filter choke and charging circuit), line reactor, main switch, semiconductor fuses, control transformer 230 V, 24 V DC power supply, motor terminals, control panel and operating panel in the door
Options	Motor choke, circuit breaker, enclosure plinth, terminal extensions, fieldbus, emergency stop button, safe torque off, enclosure lighting, enclosure heating, and much more

Type	Motor output	Output current	Dimensions in mm		
			Width	Depth (with door handle)	Height
ATV71EXC2					
D75N4H	75 kW	160 A	600	605 (642)	2157
D90N4H	90 kW	179 A	600	605 (642)	2157
C11N4H	110 kW	215 A	800	605 (642)	2157
C13N4H	132 kW	259 A	800	605 (642)	2157
C16N4H	160 kW	314 A	1200	605 (642)	2157
C20N4H	200 kW	427 A	1600	605 (642)	2157
C25N4H	250 kW	481 A	1600	605 (642)	2157
C31N4H	315 kW	616 A	2000	605 (642)	2157
C40N4H	400 kW	759 A	2000	605 (642)	2157
C50N4H	500 kW	941 A	2400	605 (642)	2157
ATV71EXC5					
D75N4H	75 kW	160 A	600	605 (642)	2237
D90N4H	90 kW	179 A	600	605 (642)	2237
C11N4H	110 kW	215 A	800	605 (642)	2237
C13N4H	132 kW	259 A	800	605 (642)	2237
C16N4H	160 kW	314 A	1200	605 (642)	2237
C20N4H	200 kW	427 A	1600	605 (642)	2237
C25N4H	250 kW	481 A	1600	605 (642)	2237
C31N4H	315 kW	616 A	2000	605 (642)	2237
C40N4H	400 kW	759 A	2000	605 (642)	2237
C50N4H	500 kW	941 A	2400	605 (642)	2237

Enclosure design 690 V	
General technical data	
Mains voltage	690 V $\pm 10\%$, 50/60 Hz $\pm 5\%$ for TT, TN-C, TN-S or IT networks
Maximum current	150 % for 60 s per 10 minutes, 165 % for 2 seconds
Output voltage	3 AC 0...110% mains voltage
Ambient temperature	0 ... +40°C, -10°C ... +50°C with enclosure heating and derating possible
Standards	CE, C-Tick, Gost, ATEX
General design	Enclosure system Spacial SF in RAL 7035 Controls in the enclosure door with additional protective cover, Cable entry from below, enclosure depth 605 mm (642 mm incl. door handle)
Interfaces	Control terminals directly on the inverter or alternatively in the enclosure, control terminals can be extended, fieldbus connection via Modbus or CANopen

ATV71EXA2●●●YH ATV71EXA5●●●YH	
IP23 with internal cooling circuit	Air flow through a grille in the enclosure door and a top mounted fan, Enclosure height of 2237 mm
IP54 with internal cooling circuit	Air flow through filter mats in enclosure door and a top mounted fan, Enclosure height of 2237 mm
Standard equipment	Frequency inverter ATV71, Active Infeed Converter, Clean Power Filter (EMC filter, line filter choke and charging circuit), line reactor, main switch, semiconductor fuses, control transformer 230 V, 24 V DC power supply, motor terminals, control panel and operating panel in the door
Options	Motor choke, circuit breaker, enclosure plinth, terminal extensions, fieldbus, emergency stop button, safe torque off, enclosure lighting, enclosure heating, and much more

Type	Motor output	Output current	Dimensions in mm		
			Width	Depth (with door handle)	Height
ATV71EXA2					
C63YH	630 kW	675 A	3800	605 (642)	2237
C80YH	800 kW	840 A	3800	605 (642)	2237
M10YH	1000 kW	1010 A	3800	605 (642)	2237
M12YH	1200 kW	1260 A	7400	605 (642)	2237
M15YH	1500 kW	1580 A	7400	605 (642)	2237
M18YH	1800 kW	1860 A	7400	605 (642)	2237
M20YH	2000 kW	2020 A	7400	605 (642)	2237
ATV71EXA5					
C63YH	630 kW	675 A	3800	605 (642)	2237
C80YH	800 kW	840 A	3800	605 (642)	2237
M10YH	1000 kW	1010 A	3800	605 (642)	2237
M12YH	1200 kW	1260 A	7400	605 (642)	2237
M15YH	1500 kW	1580 A	7400	605 (642)	2237
M18YH	1800 kW	1860 A	7400	605 (642)	2237
M20YH	2000 kW	2020 A	7400	605 (642)	2237

The product designation of the Altivar frequency inverters consists of several points of reference (characters and figures). The meaning of each point is illustrated in the following example.

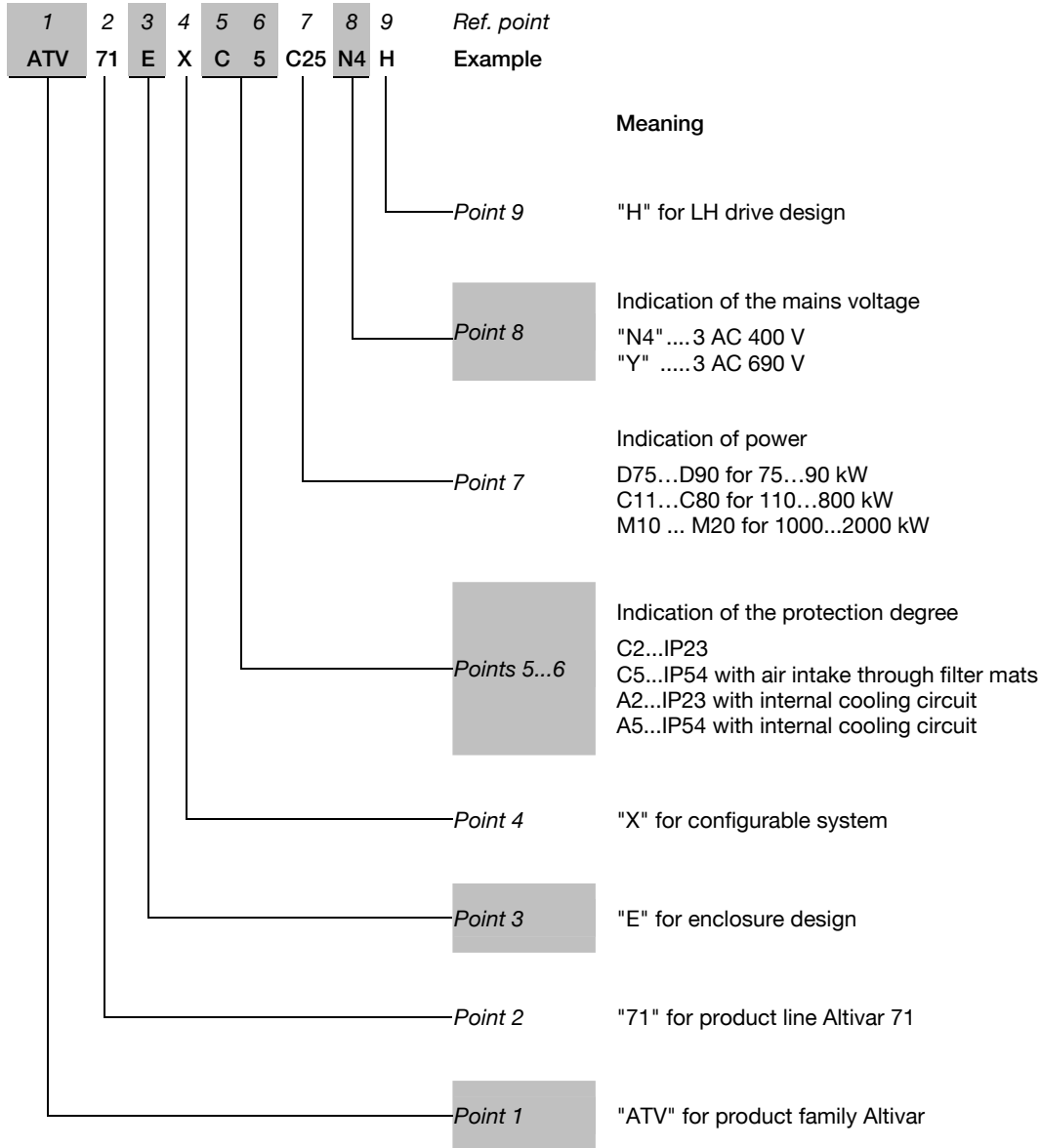

Order process for standard enclosures "Configured drive systems"

1. Choose the standard enclosure on the basis of the voltage, the power and the protection degree first.
e.g. mains voltage: 400 V; motor power: 315 kW; protection degree IP54 compact

– 1x ATV71EXC5C31N4H	Standard enclosure in protection degree IP54 compact
----------------------	--

2. Now you can select the desired options, which should be installed into the enclosure in the factory, by means of the option lists.

– 1x VW3 AE 0104	Isolating handle for switch
– 1x VW3 AE 1601	Enclosure lighting

Some options affect the dimensions of the enclosure. Please observe chapter "Width of the cubicle", page 94 for this purpose.

3. List the enclosure unit including the respective options in the order:

– 1x ATV71EXC5C31N4H	Standard enclosure in protection degree IP54 compact
– 1x VW3 AE 0104	Isolating handle for switch
– 1x VW3 AE 1601	Enclosure lighting

Specify only one standard enclosure including the respective options per order! Otherwise the assignment of the options to be installed is not possible!

Enclosure options cannot be ordered on its own! This is only possible in combination with a standard enclosure!

4. When you want to order the same enclosure configuration several times, you can simply multiply the individual positions.

– 3x ATV71EXC5C31N4H	Standard enclosure in protection degree IP54 compact
– 3x VW3 AE 0104	Isolating handle for switch
– 3x VW3 AE 1601	Enclosure lighting

Request and order of "Flexible drive systems" enclosures

For orders which contain "Options on request" or special options, proceed as follows.

1. Choose the standard enclosure on the basis of the voltage, the power and the protection degree first.
e.g. mains voltage: 400 V; motor power: 400 kW; protection degree IP23

– 1x ATV71EXC2C40N4H	Standard enclosure in protection degree IP23
----------------------	--

2. Now you can select the desired options, which should be installed into the enclosure afterwards, by means of the option lists.
Additionally specify your requests.

– 1x VW3 AE 1601	Enclosure lighting
– 1x VW3 AE 0608	Motor choke
– 1x <i>on request</i>	Special colour RAL6018 "yellow green"

Some options affect the dimensions of the enclosure. Please observe chapter "Width of the cubicle", page 94 for this purpose.

3. List the enclosure unit including the respective options for the request. Send this request to Schneider Electric Power Drives.

– 1x ATV71EXC2C40N4H	Standard enclosure in protection degree IP23
– 1x VW3 AE 1601	Enclosure lighting
– 1x VW3 AE 0608	Motor choke
– 1x <i>on request</i>	Special colour RAL6018 "yellow green"

Specify additionally the requirements for the special design in the request!

4. You will receive a quotation with a quotation number (e.g. VA-1002-09A-AL) including transfer price (net price), delivery time, terms of delivery and technical descriptions to the individual positions.

5. Please quote in the order "ATVCBL" as reference. Add the quotation number and the position in the description.

– 1x ATVCBL	as per quotation number VA-1002-09A-AL (position 1)
-------------	---

NOTICE

It is absolutely necessary to quote the position in addition to the quotation number so that the amount of the order is well-defined!

Read these instructions carefully, and look at the equipment to become familiar with the device before trying to install, operate, or maintain it. The following special messages may appear throughout this documentation or on the equipment to warn of potential hazards or to call attention to information that clarifies or simplifies a procedure.



The addition of this symbol to a Danger or Warning safety label indicates that an electrical hazard exists, which will result in personal injury if the instructions are not followed.



This is the safety alert symbol. It is used to alert you to potential personal injury hazards. Obey all safety messages that follow this symbol to avoid possible injury or death.

 DANGER
DANGER indicates an imminently hazardous situation, which, if not avoided, will result in death or serious injury.

 WARNING
WARNING indicates a potentially hazardous situation, which, if not avoided, can result in death, serious injury or equipment damage.

 CAUTION
CAUTION indicates a potentially hazardous situation, which, if not avoided, can result in injury or equipment damage.

CAUTION
CAUTION , used without the safety alert symbol, indicates a potentially hazardous situation which, if not avoided, can result in equipment damage.

NOTICE
REMARK explains a proceeding without any potentially hazardous situation.

The word "drive" as used in this manual refers to the control part of the adjustable speed drive as defined by NEC.

Electrical equipment should be installed, operated, serviced, and maintained only by qualified personnel. No responsibility is assumed by Schneider Electric for any consequences arising out of the use of this product.

© 2013 Schneider Electric. All rights reserved.

The Altivar 71 Plus Low Harmonic Drive includes an active input bridge and leads an sinusoidal mains current. So it is an alternative to active and passive filters.

State-of-the-art components, a new control concept as well as a top-quality filter module reduce the total current distortion factor THD(i) of the frequency inverter to a value less than 5 % and by this way it fulfills the requirements according to the recommendations in IEEE 519 to reduce the current harmonics in the mains.

Also in case of operation with partial load (30...120%) the Altivar 71 Plus Low Harmonic leads a sinusoidal mains current with a power factor "cos Phi" ≈ 1 .

A new control concept enables operation without damping resistors, whereby reliability is given also in case of distorted mains voltages and also the losses are significantly reduced.

Our high degree of quality awareness ranges from the basic requests in the product specification over the development of the cooling system, of the mechanical design, of the electrical circuit diagram and the individual functions up to the production of the device. This quality level is also long-term guaranteed by means of the corresponding quality assurance systems in the individual business processes and is certified every year by independent authorities according to DIN EN ISO 9001.

The range of Altivar Low Harmonic Drive Systems has been developed especially for applications in the area of industrial and commercial buildings (ventilation, air conditioning and pump technology) where the drive should contain particularly low mains harmonics. It is equipped with several motor control methods and numerous integrated functions. Thus it meets the highest demands in industry, machine building and automation.

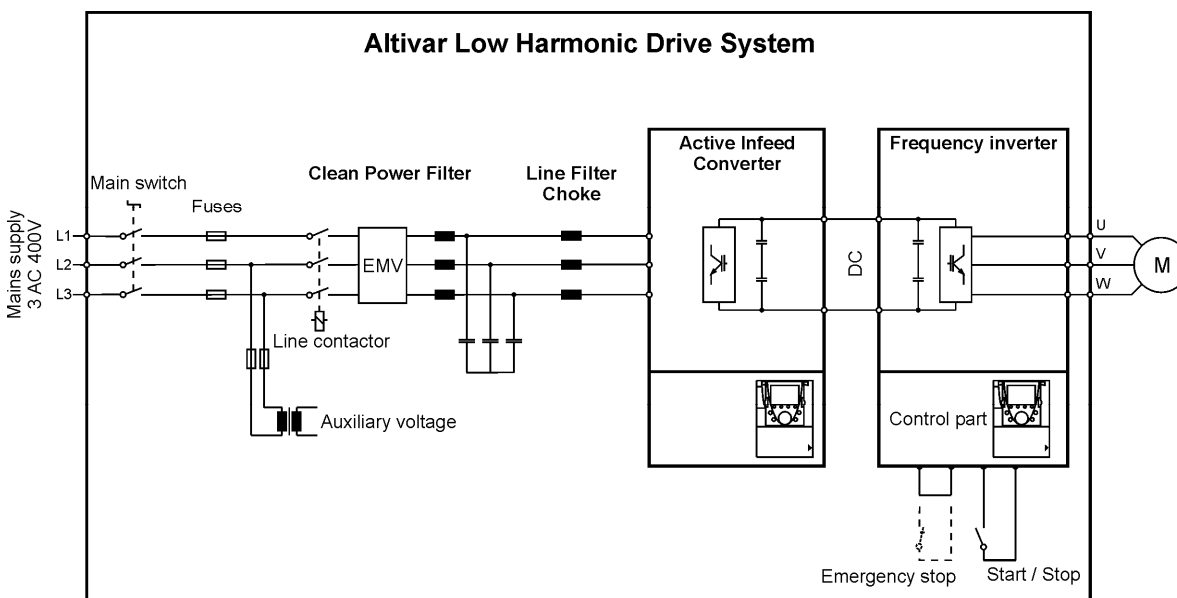

The modular construction makes it possible to adapt it to the individual requests. This makes the planning easy and helps to ensure a quick installation and commissioning of the drive.

CE Marking

All devices and drives of the electric drive engineering may cause electromagnetic interferences and otherwise they may be influenced by such interferences. Therefore, they are subject to the **EMC directive 2004/108/EEC** since 1.1.1996.

The frequency inverters have an operating voltage which is clearly in the range of 50...1000 V AC or 75...1500 V DC. Therefore, they are also subject to the **Low-voltage directive 2006/95/EEC** since 1.1.1997.

Because of the EMC filters which are built into the frequency inverters they are in conformity with **EN 61800-3** and **EN 61800-5-1**.

Frequency inverters are not considered as machines with at least one mechanically moving part. Therefore, they are not subject to the Machine directive 2006/42/EC.

NOTICE

Frequency inverters are a product of the restricted sales according to IEC 61800-3. In a residential environment this product can cause radio frequency interferences whereupon the user can be called on to take suitable measures.

The frequency inverters have a CE marking on the rating plate. However, it is necessary to observe the installation regulations to achieve the corresponding limits.

Installation regulations

- The Altivar 71 Plus-LH includes an EMC filter for industrial environments which is built-in as standard.
- Use of screened (shielded) motor cables, proper connection of the motor cables on both ends or proper laying in a metallic, closed and interconnected cable conduit
- Use of a motor choke in case of high motor cable lengths
- Use and proper connection of screened (shielded) control cables
- Grounding of the frequency inverter for human protection
- Consider the protective separation when preparing control lines and coupling relays
- Separate laying of the motor cables from other cables, especially from the control wiring

Machine safety

The power removal safety function "Safe Torque Off STO" (page 78) is available as selectable option in various safety and stop categories. So an optimal adaptation of the drive to the required safety category for the machine is possible.

Following variants of the option "Safe Torque Off" are selectable:

- **Safety category 1 with stop category 0**
with safety input at the inverter
- **Safety category 3 with stop category 0**
with Preventa safety relay
- **Safety category 3 with stop category 1**
with Preventa safety relay and monitored deceleration of the drive

NOTICE

For all selectable safety options the implementation of external safety-relevant contacts is provided. So the Altivar 71 Plus does not act as a closed safety system in terms of the Machine directive and safety standards EN/IEC 61508, ISO 13849-1 and NF EN 62061. It has to be accounted as component in any case. The safety-relevant components which are installed in the Altivar 71 Plus and their safety-relevant functionality have to be included in the whole machine safety by the engine builder.

Human protection PELV

The device fulfills the requirements for protective separation between power and electronic connections according to EN 61800-5-1.



HAZARD OF ELECTRIC SHOCK, EXPLOSION, OR ARC FLASH

Ensure that all connected external equipments fulfil the requirements for protective separation.

Failure to follow this instruction will result in death or serious injury.

Mains voltage

The Altivar 71 Plus-LH devices are designed for the following mains voltages:

- ATV71EXC●●●●N4H: 3 AC 400 (380, 415) V \pm 10 %, 50/60 Hz \pm 5 %
- ATV71EXA●●●●YH: 3 AC 690 V \pm 10 %, 50/60 Hz \pm 5 %

The nominal mains voltage must be set at the Active Infeed Converter and the inverter by means of a parameter. Thereby an optimal adjustment of the undervoltage protective function takes place.

CAUTION

INCOMPATIBLE LINE VOLTAGE

Ensure that the line voltage corresponds with the supply voltage of the frequency inverter before you switch the inverter on to configure it. An incompatible line voltage may cause damage of the inverter.

Failure to follow this instruction can result in injury or equipment damage.

Nongrounded mains

With the option "Design for IT networks" (page 79) the frequency inverter is prepared for connection to non-grounded networks.

In case of nongrounded mains a single ground (earth) fault in the supplying mains has no effect to the function of the inverter. If the ground (earth) fault occurs in the motor or the motor cables, the inverter is switched off. But the recognition heavily depends on the ground (earth) capacitance of the mains.

DANGER

HAZARD OF ELECTRIC SHOCK, EXPLOSION OR ARC FLASH

Install in IT networks only special EMC filters with very low leakage current (increase of ground (earth) capacitance,...)

Failure to follow these instructions will result in death or serious injury.

Radio frequency interferences

The frequency inverters include an EMC filter built-in as standard. This filter complies with the requirements for category "C3 – Industrial environments" according EN/IEC 61800-3 (in the past: EN 55011 class A group 2).

NOTICE

Frequency inverters are a product of the restricted sales according to IEC 61800-3. In a residential environment this product can cause radio frequency interferences whereupon the user can be called on to take suitable measures.

Mains impedance / Short-circuit current

The frequency inverters are designed considering a maximal permitted mains short-circuit current of the supply (values see technical data of the respective frequency inverter).

Optionally the devices can be also designed for higher mains short-circuit currents.

Switching rate

The Altivar 71 Plus-LH includes a line contactor which is activated in case of a start command. A stop command disconnects the power part of the Altivar 71 Plus-LH from the mains.

NOTICE

By means of the certificated control input "PWR" a "Safe Torque Off STO" of the drive is considering the safety category according to ISO 13849-1 (and IEC/EN 61800-5-2).

Inverter control	Switching rate
The Altivar 71 Plus-LH is controlled via a start/stop command.	max. 60 switching operations per hour (safety category 1, stop category 0)
Electronic lock of the inverter by means of the control input PWR "Safe Torque Off"	arbitrary (safety category 3, stop category 0 or 1)

Responsibility

All stated connection recommendations and planning remarks are to be taken merely as suggestions which must be adapted to the local conditions and regulations concerning installation and usage.

This applies especially to the safety regulations for machines, the EMC regulations and the general regulations for human protection.

 **WARNING**

HUMAN PROTECTION AND MACHINE SAFETY

Integrate the frequency inverter into the protection and safety concept of the plant or machine.

Failure to follow this instruction can result in death, serious injury and/or equipment damage.

Frequencies > 60 Hz

 **CAUTION**

OPERATION AT FREQUENCIES > 60 Hz

Check whether the used components are qualified for operation at frequencies higher than 60 Hz. Ask the manufacturer of the motor and the machine if necessary.

Failure to follow this instruction can result in injury or equipment damage.

Overvoltage protective circuit

A free-wheeling diode is provided for DC control circuits.

For AC control circuits the R/C wiring is preferable compared to a wiring with varistors because as a result not only the peak overvoltage is reduced but also the rise-time.

CAUTION

RISK OF MALFUNCTIONS IN THE CONTROL CIRCUITS

All inductances like relays, contactors, magnetic brakes, etc. have to be equipped with an overvoltage protective circuit. It helps to prevent malfunctions of the conventional device control as well as of the fieldbus.

The protective circuit must be qualified for inverter operation !

Failure to follow this instruction can result in equipment damage.

Residual current circuit breaker

Frequency inverters, especially those with additional EMC filters and screened (shielded) motor cables, lead an increased leakage current against ground (earth).

The leakage current depends on:

- the length of the motor cable
- the type of laying and whether the motor cable is screened (shielded) or not
- the set pulse frequency
- the use of an additional radio frequency interference filter
- the grounding of the motor at its installation place (grounded or nongrounded)

Depending on the conditions, the leakage current of plants with high cable lengths can be absolutely higher than 100 mA !

The built-in residual current detection has no current-limiting effect. It only helps to protect the drive and is no human protection.

CAUTION

INCORRECT TRIGGERING OF THE RESIDUAL CURRENT CIRCUIT BREAKER

Particularly because of the capacitors of the radio frequency interference filter, an unintentional triggering of a ground (earth) leakage circuit breaker may occur at the moment of switching on. As well, the ground (earth) capacitances may cause an incorrect triggering during operation. On the other hand, it is possible that the triggering is blocked by means of DC components which are caused by the mains rectification at the input of the inverter.

Therefrom, you should observe following:

- Only use short-time delayed and pulse current sensitive residual current circuit breakers with considerably higher tripping current.
- Protect the other loads by means of a separate residual current circuit breaker.
- Residual current circuit breakers in front of an inverter do not provide absolutely reliable protection in case of direct contact !! So they should be always used in combination with other protective measures.
- The frequency inverters have no current-limiting effect (in case of residual currents) and therefore they do not violate the protective multiple grounding.

Failure to follow these instructions can result in equipment damage.

Automatic restarting

In case of line fault the Altivar 71 Plus-LH changes to drive state "USA" and shows the message USA [Undervoltage alarm] at the display. When the mains voltage returns within 15 seconds and a start command is given, the drive automatically restarts.

If the mains voltage does not return within 15 seconds, the Altivar 71 Plus-LH changes to drive state "External fault" and signalizes it via the status relay.

When an automatic restart is not permitted, the following functions of the inverter can be adjusted:

- Trip state after each mains disconnection or line fault
Menu: [1.8 FAULT MANAGEMENT] (FLt-)
Parameter: *U5b* [UNDERVOLTAGE MGT]
Setting [Std fault] (0)
- Selection of the start command 2-wire control edge rated or 3-wire control

Operation without energy return

The Altivar 71 Plus-LH supplies energy back into the mains during generator operation. When this function is not desired (e.g. in case of operation at diesel generators), the following functions have to be adapted.

Active Infeed Converter AIC (LCD operating panel in the enclosure):

Menu: [4.1 Process protection]
Parameter: 4.1.01 [I max 1 generator]
Setting: 10%

Inverter Altivar 71 (LCD operating panel in the enclosure door):

Menu: [1.7 APPLICATION FUNCT.] (FUn-)
Parameter: *brR* [Dec. ramp adapt.]
Setting: [Yes] (YES)

Locking of the frequency inverter

The Altivar 71 Plus-LH devices include the standard protective function "Safe Torque Off STO" (Power Removal), which helps to prevent any unintended start-up of the motor. This function fulfills, when correctly wired, the machine standard ISO 13849-1, the IEC/EN 61508 standard for functional safety and the power drive system standard IEC/EN 61800-5-2.

Altivar 71 Plus-LH in standard enclosures for 400 V mains

The basic equipment contains:

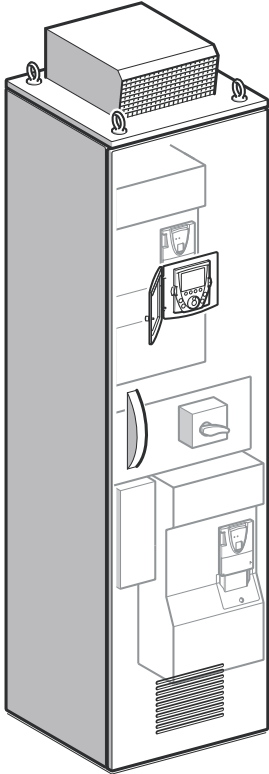

- Frequency inverter Altivar 71
- Active Infeed Converter
- Clean Power Filter with integrated EMC filter
- Line filter choke
- Mains connection on main switch
- Main switch (without door handle)
- Superfast semiconductor fuses for inverter protection
- Control transformer for 230 V AC
- 24 V DC power supply
- LCD operating panel for the inverter (mounted into the enclosure door)
- Terminals/bars for motor connection
- Protection degree IP23:
air inlet through air inlet grill in the enclosure door, air outlet through the enclosure roof.
- Protection degree IP54:
air inlet through air inlet grill in the enclosure door, air outlet through filter fans at the enclosure roof.
- Enclosure Spacial SF, color RAL 7035
- Multilingual operating instructions
- Documentation-CD-ROM with parameterization instructions, fieldbus instructions, operating and parameterizing software,...
- Enclosure layout plans consisting of circuit diagram, terminal connection table, list of materials and design drawing

Description

Altivar 71 Plus-LH

Altivar 71EX●●●●●N4H

Line supply voltage 400 V

General technical data	
Input	
Voltage	400 (380 ... 415) V ±10% for TT, TN-C, TN-S or IT networks
Frequency	50 / 60 Hz ±5 %
Total current distortion factor THD(i)	≤5 % (at nominal load on sinusoidal mains voltage)
Power factor cos phi	>0.99 (at 30...120% load)
Operating mode	4-quadrant-operation (100 % motor operation, 100 % generator operation)
Overvoltage class	Class III according to EN 50178
Output	
Control method	Vector-oriented flux control without feedback, V/f characteristic, energy saving system
Voltage	3 AC 0...110% mains voltage, dynamic voltage stabilization
Overload	50 % for 60 seconds per 10 minutes, 65 % for 2 seconds
Pulse frequency	2.5 kHz, adjustable from 2...8 kHz
Frequency / Base frequency	0.1...500 Hz / 25...500 Hz, adjustable
Short circuit protection	Short circuits and ground (earth) faults are handled by overcurrent function and switch-off the output
Design	Floor-standing enclosure
Cooling	Forced
Speed accuracy	V/f mode: slip frequency VC without feedback 0.3 x slip frequency
Mechanical strength	
Mechanical vibration	According to IEC/EN 60068-2-6 1.5 mm at 3...10 Hz, 0.6 g at 10...200 Hz (3M3 according to IEC/EN 60721-3-3)
Shock	According to IEC/EN 60068-2-27 4 g for 11 ms (3M2 according to IEC/EN 60721-3-3)
Ambient conditions	
Ambient temperature	0...+40°C (-10...+40°C with enclosure heating) 3K3 according to IEC/EN 60721-3-3 Up to +50°C with derating
Storage / Transport temperature	-25...+70°C
Protection degree	selective: ATV71EXC2●●●N4H ... IP23 ATV71EXC5●●●N4H ... IP54 with air intake through filter mats
Environmental class / Humidity	Class 3K3 in accordance with IEC/EN 60721-3-3 / no condensation, max. 95 % relative humidity
Altitude	Up to 1000 m, beyond power decrease of 1 % per 100 m up to 3000 m
Allowed pollution	Pollution degree: for IP23 design: pollution degree 2 according to EN 61800-5-1 for IP54 design: pollution degree 3 according to EN 61800-5-1 Chemical / mechanical classification: 3C2 and 3S2 according to EN 60721-3-3
Protection class	Class 1 according to EN 50178
Standards	
Basic standard	The devices are designed, built and tested on the basis of EN 61800-2, EN 61800-3, EN 61800-5-1 and EN 60204-1.
EMC immunity	According to EN 61800-3, 1st and 2nd environment (IEC 1000-4-2; IEC 1000-4-3; IEC 1000-4-4; IEC 1000-4-5; IEC 1000-4-6)
EMC emission	In accordance with product standard EN 61800-3, 2 nd environment, category C3
Insulation	Galvanic insulation in accordance with EN 61800-5-1 PELV (Protective Extra Low Voltage)
Standards	CE, C-Tick, Gost, ATEX

NOTICE

Frequency inverters are a product of the restricted sales according to IEC 61800-3. In a residential environment this product can cause radio frequency interferences whereupon the user can be called on to take suitable measures.

Protection degree ATV71EXC●

In order to adapt the utmost robust Altivar product line with enclosure design optimal to the individual requests of the system, these enclosure units are available in two different designs. Each solution contains a clearly specified and tested cooling system.

The standard design of the Altivar 71 Plus-LH enclosure units complies with protection degree IP23. If a higher protection degree is desired or required, there is an IP54 solution available.

Overview of standardised protection degrees

ATV71EXC2 - Standard enclosure design IP23

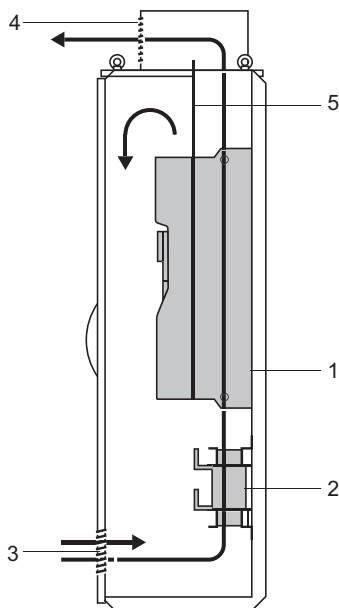

In this case the input of the cooling air takes place by the enclosure door and the output through the top of the enclosure. The fan of the power part, which is inside the device, provides the exhaust of the enclosure.

- 1 Frequency inverter ATV71 and Active Infeed Converter
- 2 Clean Power Filter components
- 3 Air inlet grid (without filter mat) for control part and power part
- 4 Metal cover with splash water protection
- 5 Guided air flow to avoid internal air short-cuts

Protection degree: IP23

Air inlet temperature: 0...+40°C (-10...+40°C with enclosure heating)

ATV71EXC5 - Enclosure design IP54

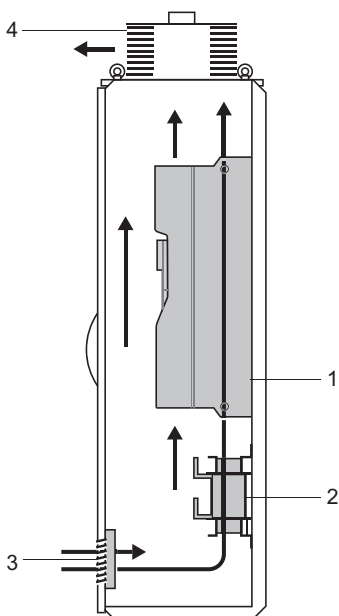

At protection degree IP54 with filter mats the input of the cooling air takes place through the filter mats in the enclosure door and the output through the fan at the top of the enclosure.

- 1 Frequency inverter ATV71 and Active Infeed Converter
- 2 Clean Power Filter components
- 3 Air inlet grid (with filter mat)
- 4 Fan (with filter mat)

Protection degree: IP54

Air inflow temperature: 0...+40°C (-10...+40°C with enclosure heating)

Altivar 71 Plus-LH

Altivar 71EX●●●●●N4H

Line supply voltage 400 V

Technical data

Type	ATV71EXC● D75N4H	D90N4H	
Built-in standard device	ATV71HD75N4	ATV71HD90N4D	
Nominal data			
Motor rating			
P_N [kW]	$V_N = 400$ V	75	90
Continuous output current			
I_N [A]	$V_N = 400$ V	160	179
Maximum current for 60 s per 10 minutes			
I_{MAX} [A]	$V_N = 400$ V	240	269
Input			
Input current			
I_{IN} [A]	$V_N = 400$ V	126	150
I_{Harm} [A] ¹⁾	$V_N = 400$ V	6	7.1
Continuous apparent power			
S_N [kVA]	$V_N = 400$ V	87	104
Characteristics			
Losses [W]	at I_N	4820	4890
Weight net/gross [kg]			
ATV71EXC2●●●N4H	420 / 465	435 / 480	
ATV71EXC5●●●N4H	420 / 465	435 / 480	
Ambient conditions			
Air flow [m ³ /h]		880	880
Sound pressure level [dB(A)]	EXC2 / EXC5	77 / 76	77 / 76
Mains short circuit current [kA] ²⁾		100 ³⁾	100 ³⁾

¹⁾ ... Value valid at sinusoidal mains voltage.

²⁾ ... Value valid for 200ms.

³⁾ ... Value valid in combination with option circuit breaker or with pre-fuses, see chapter "Fuses and cable cross sections".

Dimensions: IP23CV Compact version

ATV71EXC2D75N4H, D90N4H

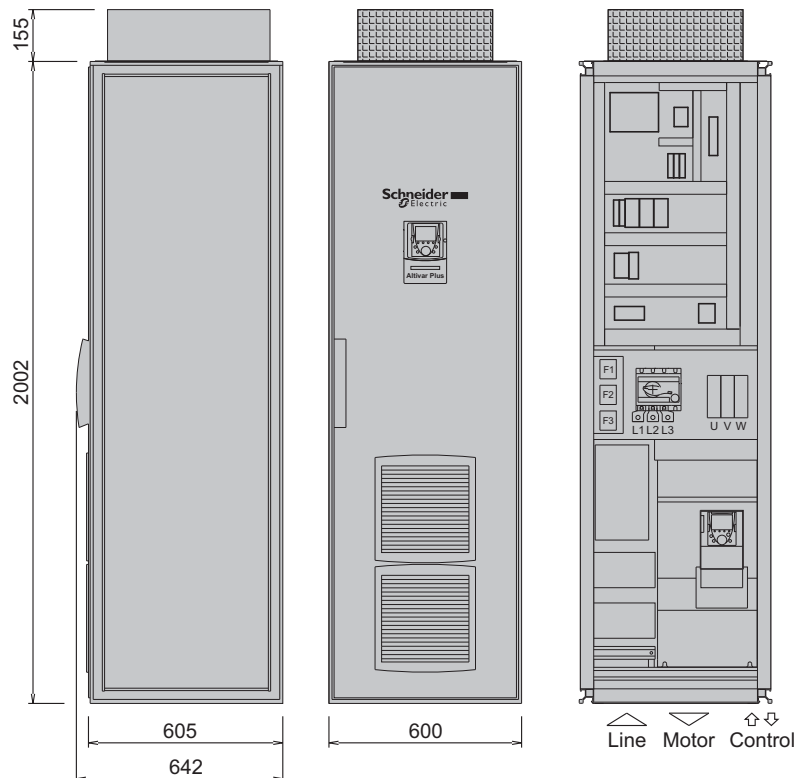

Altivar 71 Plus-LH

Altivar 71EX●●●●●N4H

Line supply voltage 400 V

Dimensions: IP54CV Compact version

ATV71EXC5D75N4H, D90N4H

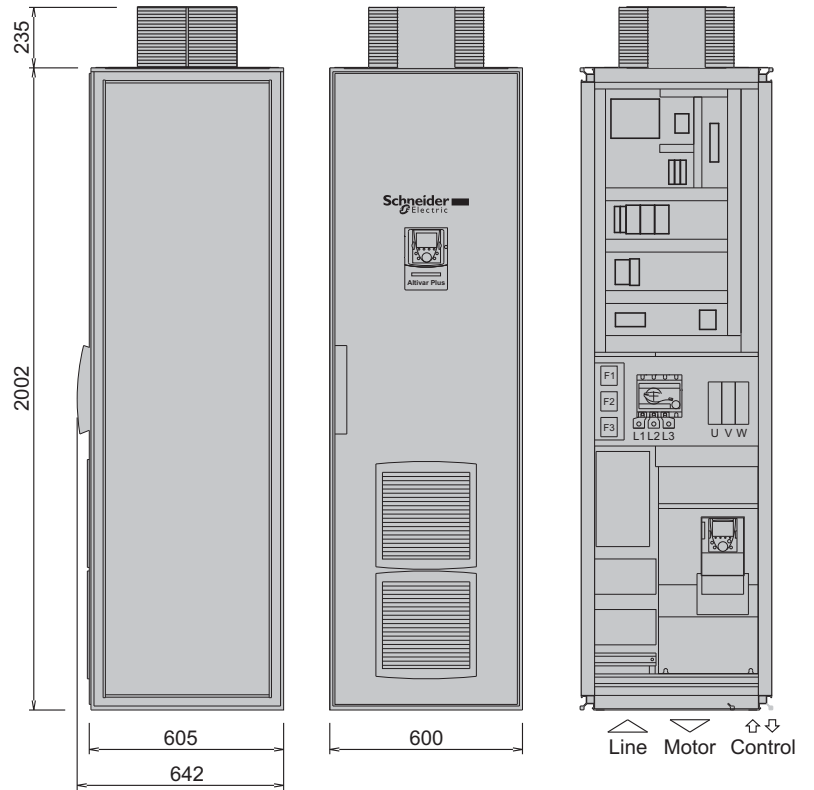

NOTICE

The total dimensions of the enclosure including options are given in chapter "Width of the cubicle", page 94.

Type	ATV71EXC● C11N4H	C13N4H	
Built-in standard device	ATV71HC11N4D	ATV71HC13N4D	
Nominal data			
Motor rating			
P_N [kW]	$V_N = 400$ V	110	132
Continuous output current			
I_N [A]	$V_N = 400$ V	215	259
Maximum current for 60 s per 10 minutes			
I_{MAX} [A]	$V_N = 400$ V	323	388
Input			
Input current			
I_{IN} [A]	$V_N = 400$ V	177	212
I_{Harm} [A] ¹⁾	$V_N = 400$ V	8.4	10.1
Continuous apparent power			
S_N [kVA]	$V_N = 400$ V	123	147
Characteristics			
Losses [W]	at I_N	5730	6490
Weight net/gross [kg]			
ATV71EXC2●●●N4H		555 / 605	560 / 610
ATV71EXC5●●●N4H		550 / 600	555 / 605
Ambient conditions			
Air flow [m ³ /h]		1200	1200
Sound pressure level [dB(A)]	EXC2 / EXC5	69 / 76	69 / 76
Mains short circuit current [kA] ²⁾		100 ³⁾	100 ³⁾

¹⁾ ... Value valid at sinusoidal mains voltage.

²⁾ ... Value valid for 200ms.

³⁾ ... Value valid in combination with option circuit breaker or with pre-fuses, see chapter "Fuses and cable cross sections".

Dimensions: IP23CV Compact version

ATV71EXC2C11N4H, C13N4H

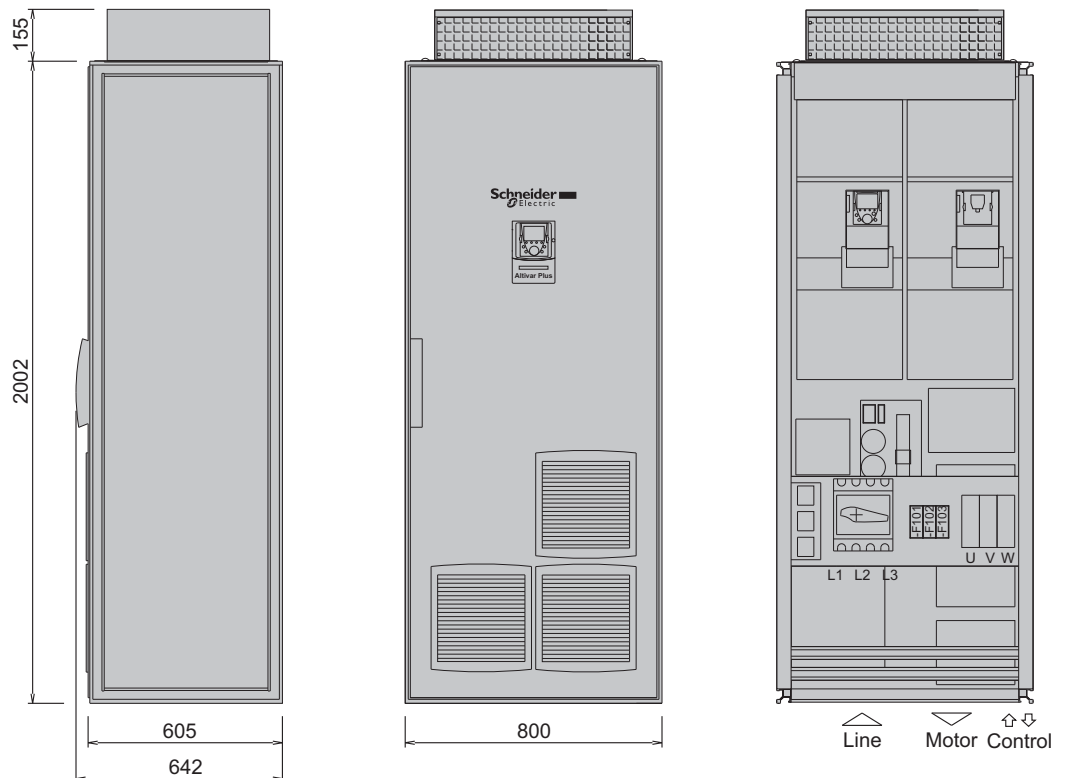

Altivar 71 Plus-LH

Altivar 71EX●●●●●N4H

Line supply voltage 400 V

Dimensions: IP54CV Compact version

ATV71EXC5C11N4H, C13N4H

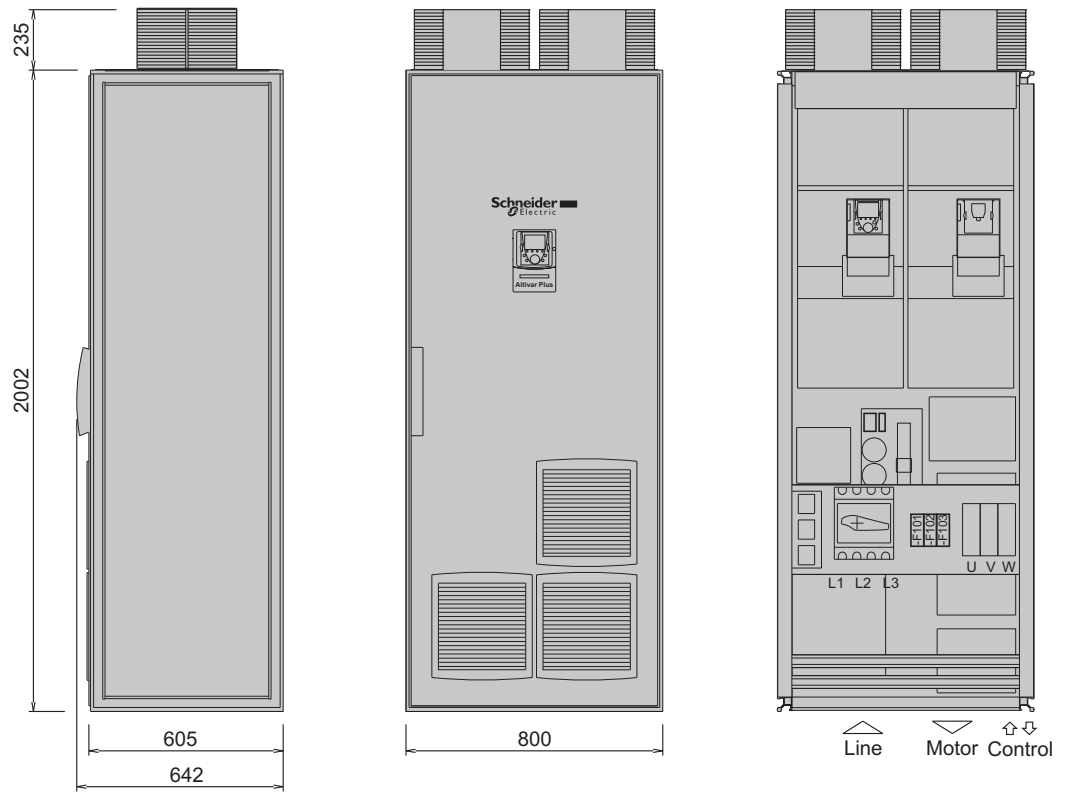

NOTICE

The total dimensions of the enclosure including options are given in chapter "Width of the cubicle", page 94.

Type		ATV71EXC● C16N4H
Built-in standard device		ATV71HC16N4D
Nominal data		
Motor rating		
P_N [kW]	$V_N = 400$ V	160
Continuous output current		
I_N [A]	$V_N = 400$ V	314
Maximum current for 60 s per 10 minutes		
I_{MAX} [A]	$V_N = 400$ V	471
Input		
Input current		
I_{IN} [A]	$V_N = 400$ V	255
I_{Harm} [A] ¹⁾	$V_N = 400$ V	12.1
Continuous apparent power		
S_N [kVA]	$V_N = 400$ V	177
Characteristics		
Losses [W]	at I_N	7450
Weight net/gross [kg]		
ATV71EXC2●●●N4H		755 / 820
ATV71EXC5●●●N4H		745 / 810
Ambient conditions		
Air flow [m ³ /h]		1600
Sound pressure level [dB(A)]	EXC2 / EXC5	70 / 77
Mains short circuit current [kA] ²⁾		100 ³⁾

¹⁾ ... Value valid at sinusoidal mains voltage.

²⁾ ... Value valid for 200ms.

³⁾ ... Value valid in combination with option circuit breaker or with pre-fuses, see chapter "Fuses and cable cross sections".

Dimensions: IP23CV Compact version

ATV71EXC2C16N4H

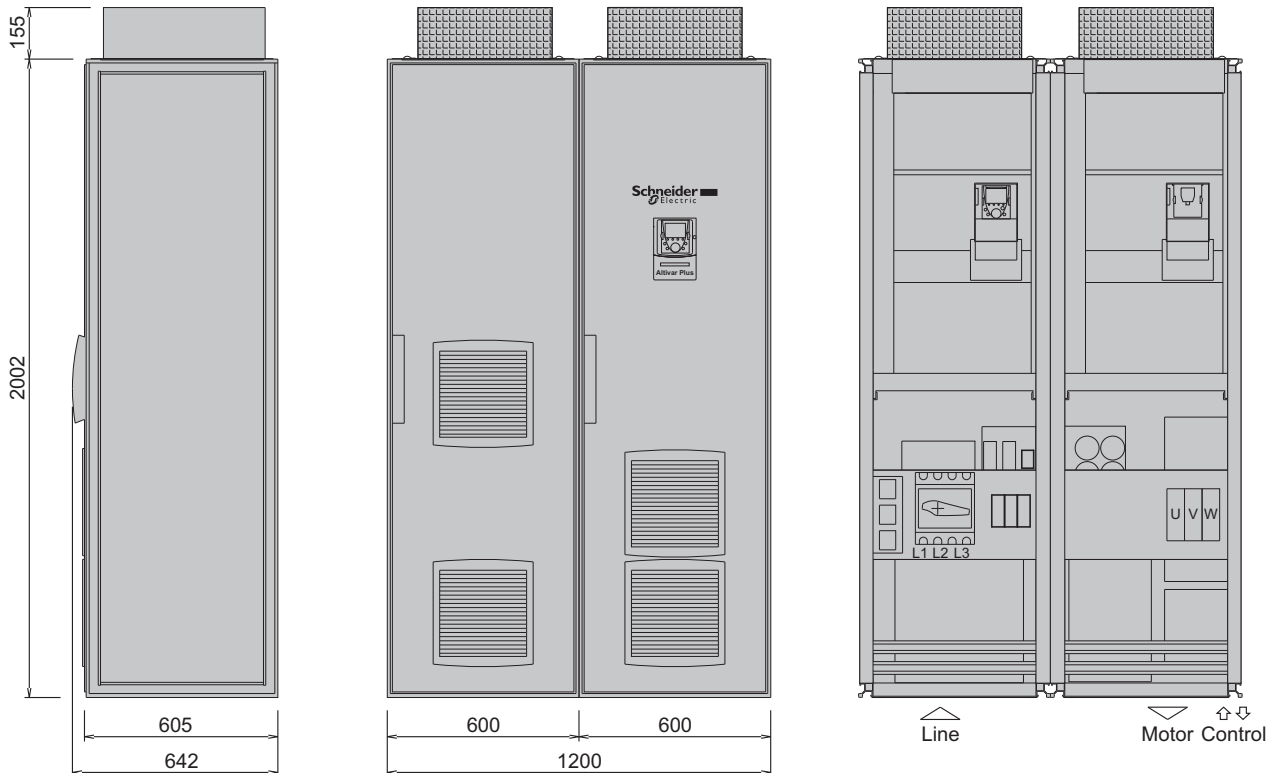

Altivar 71 Plus-LH

Altivar 71EX●●●●●N4H

Line supply voltage 400 V

Dimensions: IP54CV Compact version

ATV71EXC5C16N4H

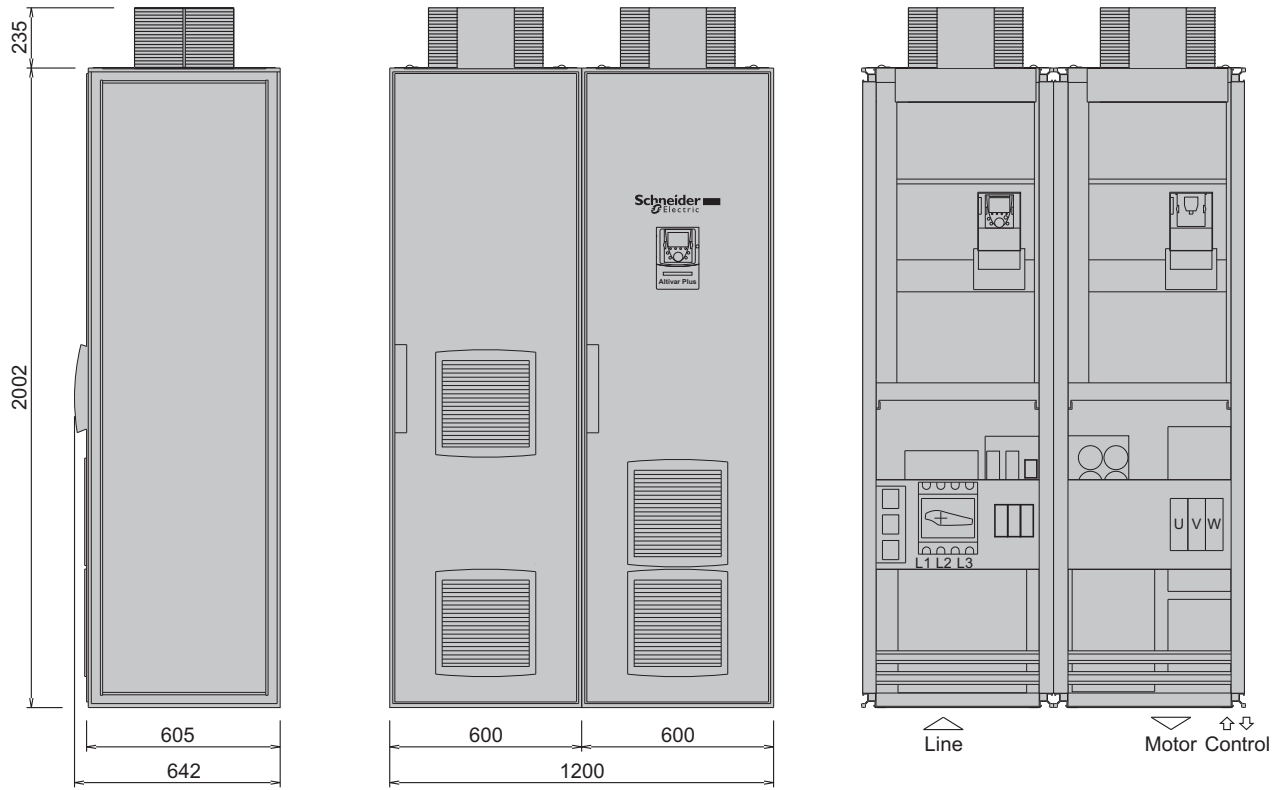

NOTICE

The total dimensions of the enclosure including options are given in chapter "Width of the cubicle", page 94.

Type	ATV71EXC● C20N4H	C25N4H	
Built-in standard device	ATV71HC20N4D	ATV71HC25N4D	
Nominal data			
Motor rating			
P_N [kW]	$V_N = 400$ V	200	250
Continuous output current			
I_N [A]	$V_N = 400$ V	387	481
Maximum current for 60 s per 10 minutes			
I_{MAX} [A]	$V_N = 400$ V	580	721
Input			
Input current			
I_{IN} [A]	$V_N = 400$ V	320	395
I_{Harm} [A] ¹⁾	$V_N = 400$ V	15.2	18.8
Continuous apparent power			
S_N [kVA]	$V_N = 400$ V	222	274
Characteristics			
Losses [W]	at I_N	9130	11270
Weight net/gross [kg]			
ATV71EXC2●●●N4H		900 / 980	900 / 980
ATV71EXC5●●●N4H		915 / 995	915 / 995
Ambient conditions			
Air flow [m ³ /h]		2400	2400
Sound pressure level [dB(A)]	EXC2 / EXC5	70 / 78	70 / 78
Mains short circuit current [kA] ²⁾		100 ³⁾	100 ³⁾

¹⁾ ... Value valid at sinusoidal mains voltage.

²⁾ ... Value valid for 200ms.

³⁾ ... Value valid in combination with option circuit breaker or with pre-fuses, see chapter "Fuses and cable cross sections".

Dimensions: IP23CV Compact version

ATV71EXC2C20N4H, C25N4H

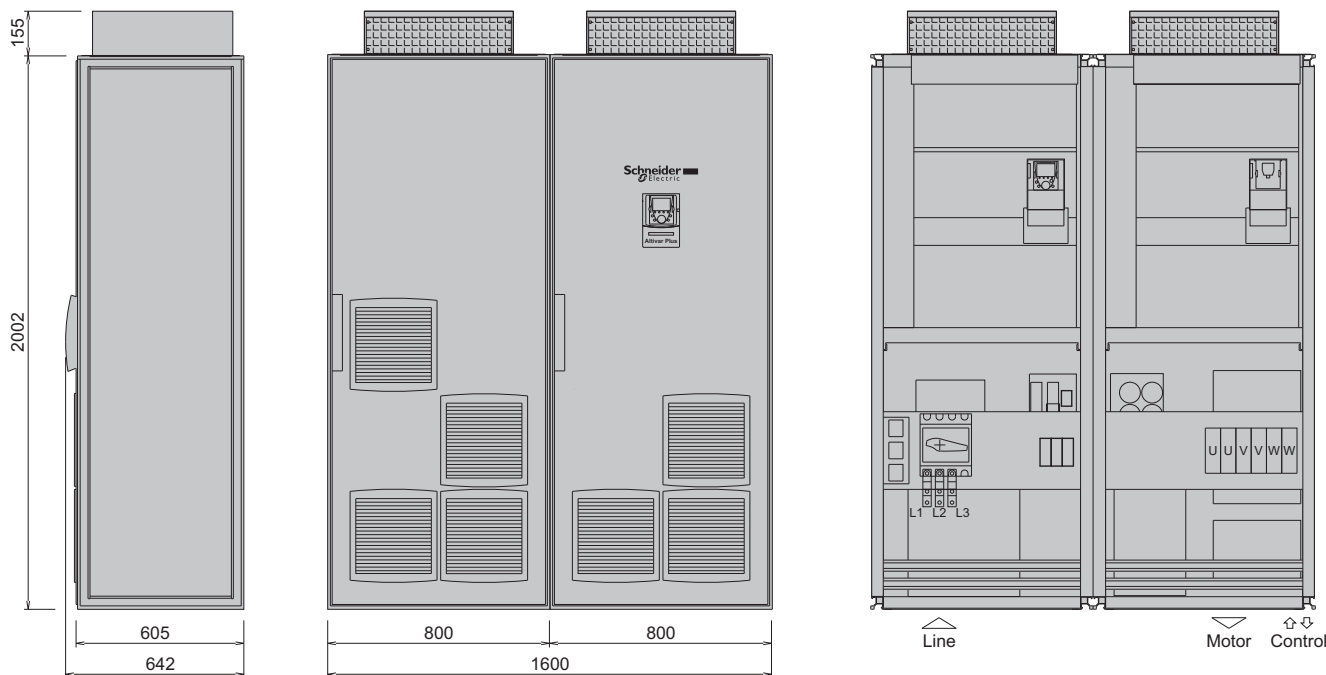

Altivar 71 Plus-LH

Altivar 71EX●●●●●N4H

Line supply voltage 400 V

Dimensions: IP54CV Compact version

ATV71EXC5C20N4H, C25N4H

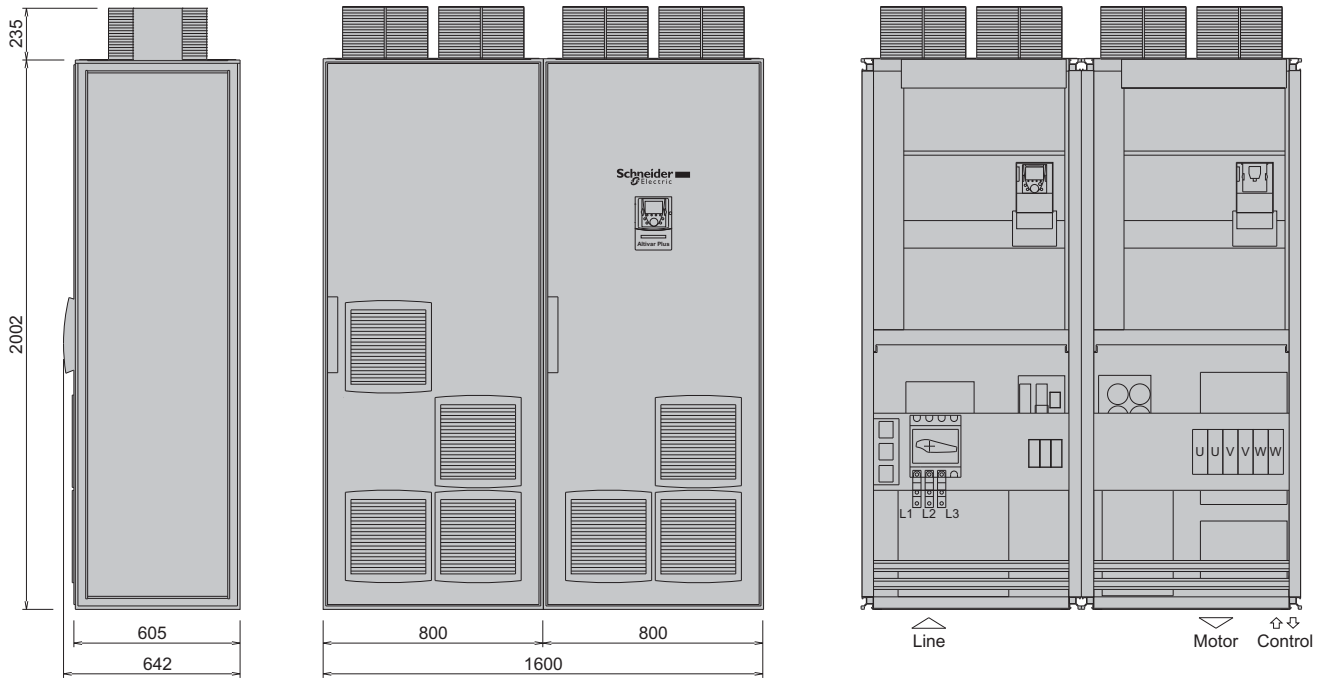

NOTICE

The total dimensions of the enclosure including options are given in chapter "Width of the cubicle", page 94.

Type	ATV71EXC● C31N4H		C40N4H
Built-in standard device	ATV71HC31N4D		ATV71HC40N4D
Nominal data			
Motor rating			
P_N [kW]	$V_N = 400$ V	315	400
Continuous output current			
I_N [A]	$V_N = 400$ V	616	759
Maximum current for 60 s per 10 minutes			
I_{MAX} [A]	$V_N = 400$ V	924	1138
Input			
Input current			
I_{IN} [A]	$V_N = 400$ V	495	628
I_{Harm} [A] ¹⁾	$V_N = 400$ V	23.6	29.9
Continuous apparent power			
S_N [kVA]	$V_N = 400$ V	343	435
Characteristics			
Losses [W]	at I_N	13900	17370
Weight net/gross [kg]			
ATV71EXC2●●●N4H		1360 / 1455	1370 / 1465
ATV71EXC5●●●N4H		1375 / 1470	1385 / 1480
Ambient conditions			
Air flow [m ³ /h]		3600	3600
Sound pressure level [dB(A)]	EXC2 / EXC5	71 / 79	71 / 79
Mains short circuit current [kA] ²⁾		70 ³⁾ , 100 ⁴⁾	70 ³⁾ , 100 ⁴⁾

¹⁾ ... Value valid at sinusoidal mains voltage.

²⁾ ... Value valid for 200ms.

³⁾ ... Value valid with option circuit breaker.

⁴⁾ ... Value valid in combination with pre-fuses, see chapter "Fuses and cable cross sections".

Dimensions: IP23CV Compact version

ATV71EXC2C31N4H, C40N4H

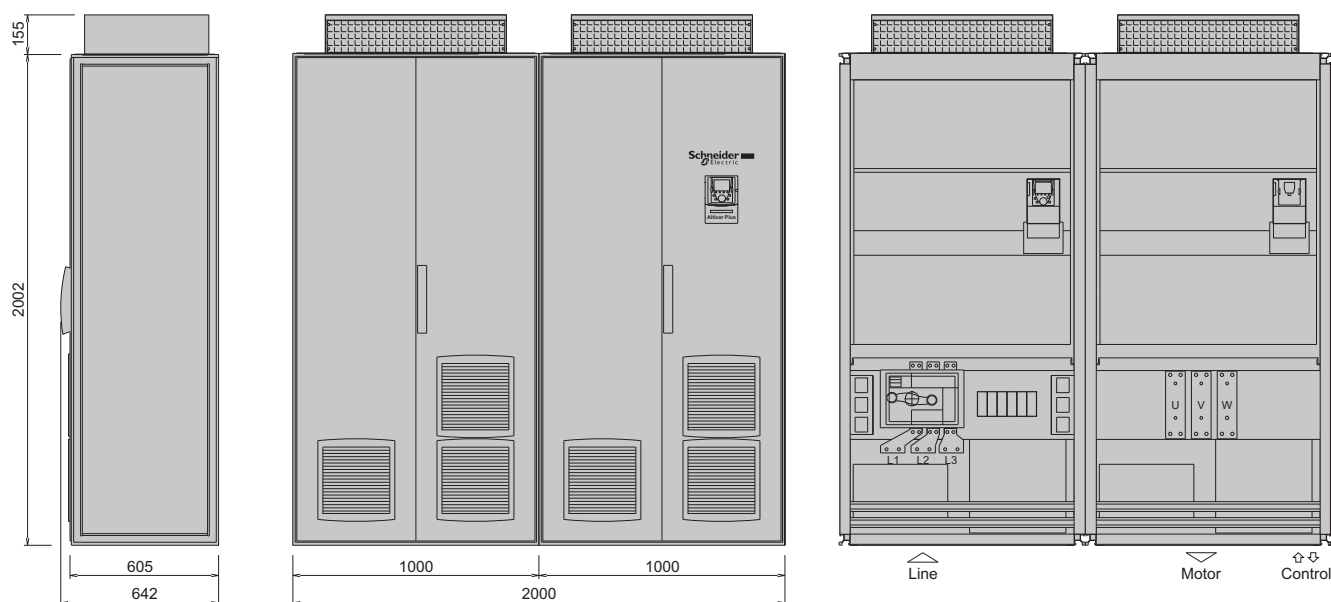

Altivar 71 Plus-LH

Altivar 71EX●●●●●N4H

Line supply voltage 400 V

Dimensions: IP54CV Compact version

ATV71EXC5C31N4H, C40N4H

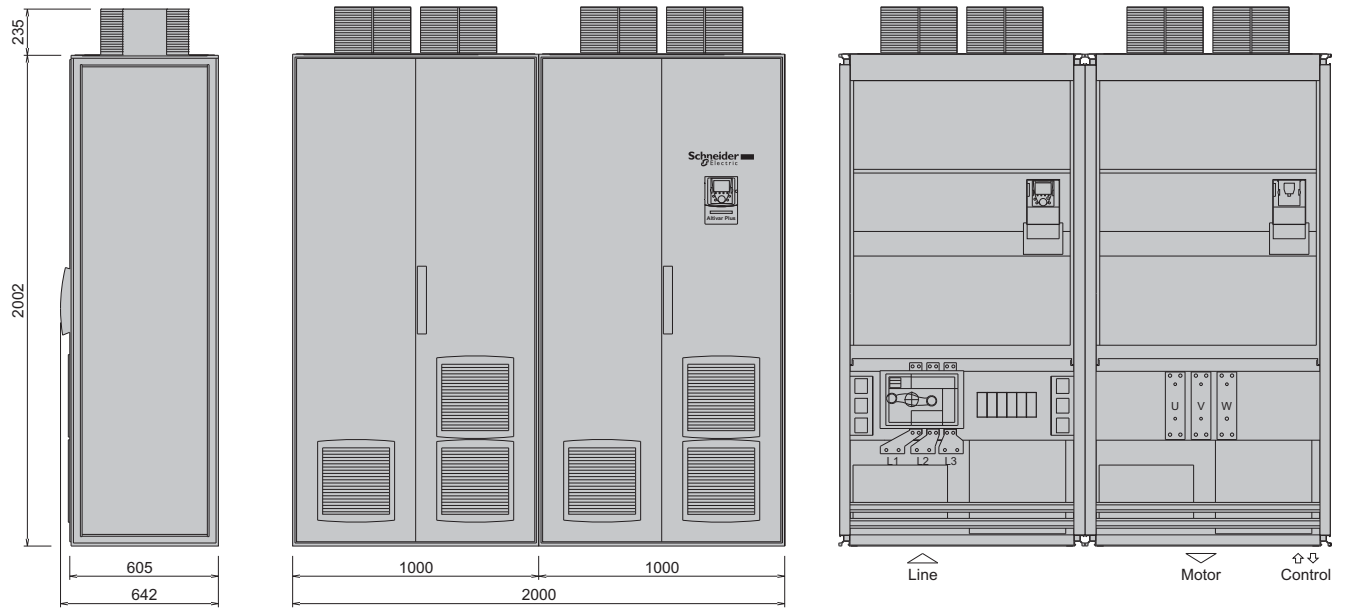

NOTICE

The total dimensions of the enclosure including options are given in chapter "Width of the cubicle", page 94.

Type		ATV71EXC● C50N4H
Built-in standard device		ATV71HC50N4D
Nominal data		
Motor rating		
P_N [kW]	$V_N = 400$ V	500
Continuous output current		
I_N [A]	$V_N = 400$ V	941
Maximum current for 60 s per 10 minutes		
I_{MAX} [A]	$V_N = 400$ V	1411
Input		
Input current		
I_{IN} [A]	$V_N = 400$ V	780
I_{Harm} [A] ¹⁾	$V_N = 400$ V	37.1
Continuous apparent power		
S_N [kVA]	$V_N = 400$ V	540
Characteristics		
Losses [W]	at I_N	21310
Weight net/gross [kg]		
ATV71EXC2●●●N4H		1650 / 1755
ATV71EXC5●●●N4H		1665 / 1770
Ambient conditions		
Air flow [m ³ /h]		4800
Sound pressure level [dB(A)]	EXC2 / EXC5	72 / 79
Mains short circuit current [kA] ²⁾		70 ³⁾ , 100 ⁴⁾

¹⁾ ... Value valid at sinusoidal mains voltage.

²⁾ ... Value valid for 200ms.

³⁾ ... Value valid with option circuit breaker.

⁴⁾ ... Value valid in combination with pre-fuses, see chapter "Fuses and cable cross sections".

Dimensions: IP23CV Compact version

ATV71EXC2C50N4H

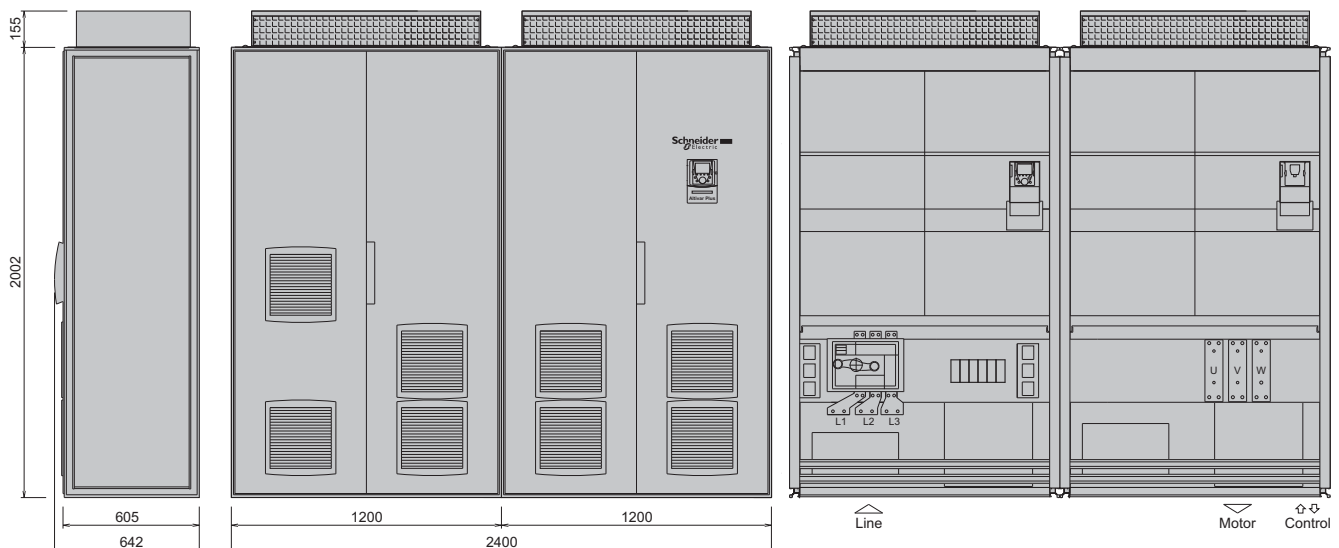

Altivar 71 Plus-LH

Altivar 71EX●●●●●N4H

Line supply voltage 400 V

Dimensions: IP54CV Compact version

ATV71EXC5C50N4H

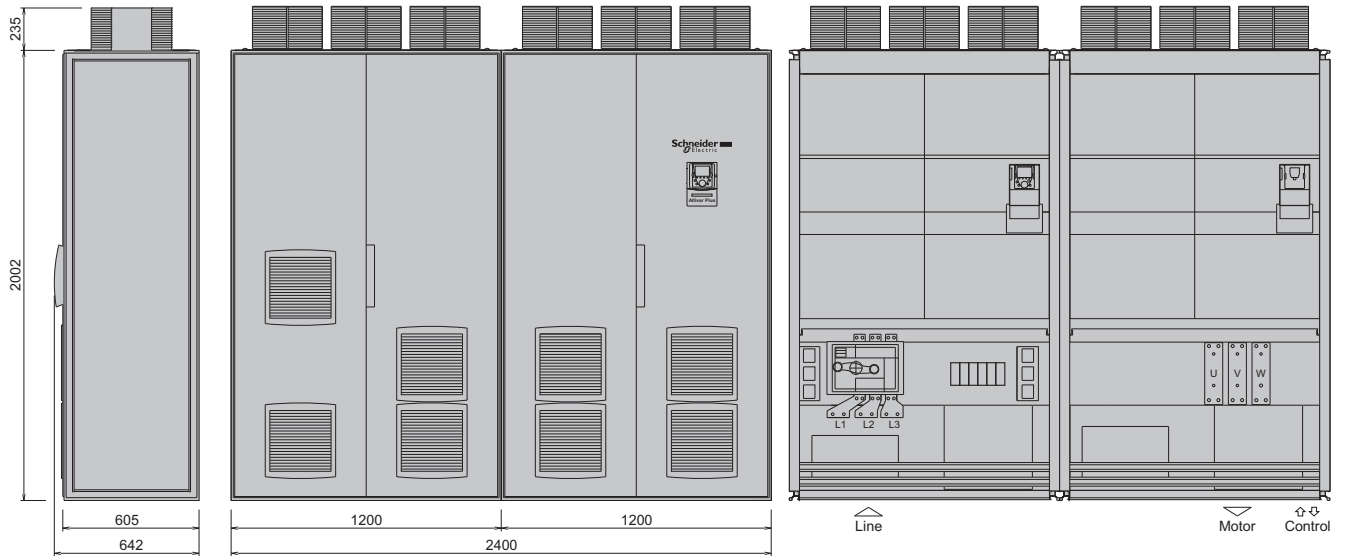

NOTICE

The total dimensions of the enclosure including options are given in chapter "Width of the cubicle", page 94.

Power decrease

Depending on the chosen pulse frequency and the maximum ambient temperature a power increase is possible or a power reduction is necessary. This can be determined by means of the following diagrams.

ATV 71EXC●D75N4H ... EXC●C50N4H

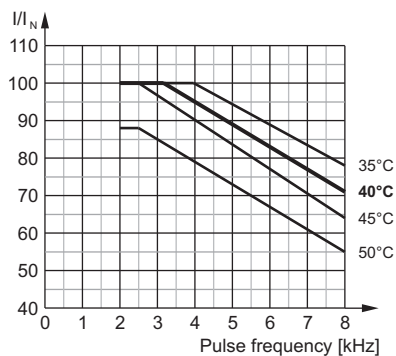

Please observe the following guidelines for operation of the drive:

- At higher pulse frequencies the allowed motor cable length is reduced (see chapter "Motor cable lengths").
- Do not select a motor which is more than one power rating bigger than the drive.

NOTICE

If the heat sink temperature is too high, the pulse frequency is automatically reduced which helps to prevent an overload of the inverter.

Fuses and cable cross sections

The Altivar enclosure designs have input fuses built-in as standard. These fuses are for the case that the electronic protective mechanism of the inverter did not work. So they are a secondary protection of the inverter.

The below-mentioned diameters for 3-wire cables are recommended values for laying the cable in air at max. 40°C ambient temperature, based on the regulations ÖVN EN 1 and VDE 0100.

The motor cables are dimensioned for the maximum continuous current. They apply to 0...100 Hz (up to 300 Hz the cable losses increase about 25 % because of the Skin-effect).

An alternative to screened (shielded) motor cables is the use of NYCY or NYCWY cables (power cables with concentric protective conductor).

DANGER

HAZARD OF ELECTRIC SHOCK, EXPLOSION, OR ARC FLASH

- In case of other ambient conditions and different regulations the cable diameters must be adjusted.
- The dimensioning of the pre-fuses, mains cable cross sections and mains cable length has to be done in observance to the available mains short circuit current to ensure a safe switch-off in case of a fault!

If required increase the power of the transformer to reach the necessary short circuit capability.

- If the mains fuses blow the inverter already has a primary defect. Therefore, exchanging the blown fuses and switching the inverter on again without any check is not effective.

Failure to follow these instructions will result in death or serious injury.

Cable cross sections									
		Mains supply			Internal fuse (per phase)	Motor output		Recommended cable [mm ²]	
		No. of phases	Pre-fuse (per phase)	Recommended cable [mm ²]		Max. cable [mm ²] (per phase)	Max. cable (with motor choke) [mm ²] (per phase)		
ATV71EX●●	D75N4H	3	200A	1x (3x 95)	2x 185 (M12)	200 A aR	2x 150 (M10)	2x 150 (M10)	1x (3x 70)
	D90N4H	3	200A	1x (3x 95)	2x 185 (M12)	200 A aR	2x 150 (M10)	2x 150 (M10)	1x (3x 95)
	C11N4H	3	250A	1x (3x 120)	2x 150 (M10)	250 A aR	2x 240 (M12)	2x 240 (M12)	1x (3x 120)
	C13N4H	3	315A	2x (3x 95)	2x 150 (M10)	315 A aR	2x 240 (M12)	2x 240 (M12)	1x (3x 150)
	C16N4H	3	400A	2x (3x 120)	2x 150 (M10)	350 A aR	2x 240 (M12)	2x 240 (M12)	2x (3x 95)
	C20N4H	3	500A	2x (3x 150)	2x 300 (M10) ¹⁾	450 A aR	4x 240 (M12)	4x 240 (M12)	2x (3x 120)
	C25N4H	3	630A	2x (3x 185)	3x 185 (M12)	550 A aR	4x 240 (M12)	4x 240 (M12)	2x (3x 150)
	C31N4H	3	800A	3x (3x 185)	4x 300 (M12) ¹⁾	2x 350 A aR	4x 240 (M12)	4x 240 (M12)	3x (3x 150)
	C40N4H	3	1000A	4x (3x 185)	4x 300 (M12) ¹⁾	2x 450 A aR	4x 240 (M12)	4x 240 (M12)	3x (3x 185)
	C50N4H	3	1250A	4x (3x 240)	6x 300 (M12) ¹⁾	2x 550 A aR	6x 240 (M12)	6x 240 (M12)	4x (3x 185)

1)..... Connection only with special cable lugs for switching devices possible

NOTICE

Differing cable cross sections on request.

Cable cross sections at cable entry via the top									
		Mains supply				Internal fuse (per phase)	Motor output		
		No. of phases	Pre-fuse (per phase)	Recommended cable [mm ²]	Max. cable [mm ²] (per phase)		Max. cable (without motor choke) [mm ²] (per phase)	Max. cable (with motor choke) [mm ²] (per phase)	Recommended cable [mm ²]
ATV71EX●●	D75N4H	3	200A	1x (3x 95)	2x 150 (M10)	200 A aR	2x 150 (M10)	2x 150 (M10)	1x (3x 70)
	D90N4H	3	200A	1x (3x 95)	2x 150 (M10)	200 A aR	2x 150 (M10)	2x 150 (M10)	1x (3x 95)
	C11N4H	3	250A	1x (3x 120)	2x 185 (M12)	250 A aR	2x 185 (M12)	2x 185 (M12)	1x (3x 120)
	C13N4H	3	315A	1x (3x 185)	2x 185 (M12)	315 A aR	2x 185 (M12)	2x 185 (M12)	1x (3x 150)
	C16N4H	3	400A	2x (3x 120)	2x 185 (M12)	350 A aR	2x 185 (M12)	2x 185 (M12)	2x (3x 95)
	C20N4H	3	500A	2x (3x 150)	4x 240 (M12)	450 A aR	4x 240 (M12)	4x 240 (M12)	2x (3x 120)
	C25N4H	3	630A	2x (3x 185)	4x 240 (M12)	550 A aR	4x 240 (M12)	4x 240 (M12)	2x (3x 150)
	C31N4H	3	800A	3x (3x 185)	4x 240 (M12)	2x 350A A aR	4x 240 (M12)	4x 240 (M12)	3x (3x 150)
	C40N4H	3	1000A	4x (3x 185)	4x 240 (M12)	2x 450A A aR	4x 240 (M12)	4x 240 (M12)	3x (3x 185)
	C50N4H	3	1250A	4x (3x 240)	6x 240 (M12)	2x 550A A aR	6x 240 (M12)	6x 240 (M12)	4x (3x 185)

NOTICE

Differing cable cross sections on request.

Motor cable lengths

Because of the permitted mains disturbances, the allowed overvoltages at the motor, the occurring bearing currents and the permitted heat losses the distance between inverter and motor(s) is limited. The maximum distance heavily depends on the type of motor cable (screened/unscreened) as well as from the used options.

Overvoltages at the motor

Overvoltages at the motor terminals result from reflection in the motor cable. Basically the motors are stressed with measurable higher voltage peaks from a motor cable length of 50 m. Thereby the motor load is nearly independent from the used inverter !

Line supply voltage 400 V Motor insulation for 1300 V phase-to-phase peak voltage and dv/dt resistance > 8 kV/μs

In order to use standard motors in this voltage range, the Altivar frequency inverters have a function to inhibit short output voltage pulses. With this function the reflection conditional overvoltages are attenuated. The slew rate as well as the EMC load are not influenced by changing this parameter.

At even longer motor cables the use of a "dv/dt filter" is required. Combined with the cable capacitance the option motor choke affects like a filter and limits the voltage peaks at the motor as well as the slew rate of the output pulses.

When the specified motor cable lengths are observed the motor life time can be significantly extended.

Line supply voltage 400 V max. 1000 V phase-to-phase peak voltage and dv/dt < 500 V/μs

CAUTION

RISK OF OVERVOLTAGE AT THE MOTOR

Observe the specified length of motor cables in order to protect the motor !

Failure to follow these instructions can result in equipment damage.

EMC interferences

The Altivar 71 Plus-LH causes high-frequent interferences which drain off more and more stronger to the ground (earth) potential with increasing motor cable length. As a result the line-conducted interferences to the mains increase. The attenuation of the line reactors is not longer sufficient and the permitted interference limits are exceeded.

NOTICE

Observing the specified length of motor cables is also necessary for compliance with the EMC limits.

Bearing currents

Common mode bearing currents are significantly reduced by use of the option motor choke.

Especially in case of big motors with middle up to high motor cable lengths the option motor choke is considerable to increase the availability of the motor.

Multiplication factors

In case of different conditions the recommended cable lengths have to be converted by means of the following factors.

If several factors apply, please multiply them.

- The pulse frequency does not correspond to factory default:

at 4 kHz multiply values by 0.7
 at 8 kHz multiply values by 0.4

- In case of output frequencies higher than 100 Hz:

up to 200 Hz multiply values by 0.8
 up to 300 Hz multiply values by 0.5

- Instead of two parallel cables one thicker cable is used: multiply values by 1.5

- In case of 6-pole motor cabling (e.g. for star/delta starting circuit): multiply values by 0.75

- In case of parallel motors with a dedicated cable to each motor the inverter values have to be converted in compliance with the number of motors. When a motor choke is used for each motor, the following values in brackets apply.

at 2 motors multiply values by 0.40 (0.80)
 at 3 motors multiply values by 0.25 (0.60)
 at 4 motors multiply values by 0.15 (0.40)
 at 5 motors multiply values by 0.10 (0.25)

- In case of parallel motors with a common cable to all motors the inverter values have to be converted in compliance with the number of motors:

at 2 motors multiply values by 0.80
 at 3 motors multiply values by 0.60
 at 4 motors multiply values by 0.40
 at 5 motors multiply values by 0.25

Recommended maximum lengths of motor cables in 2nd environment (industrial environment)

C3 (EN 55011 - class A group 2)

no option *)	50 m	screened (shielded) cable
with motor choke	80 m	screened (shielded) cable

C4 (EMC concept)

no option *)	100 m	screened (shielded) cable
with motor choke	300 m	screened (shielded) cable
no option *)	150 m	unscreened (unshielded) cable
with motor choke	300 m	unscreened (unshielded) cable

*) By means of a software function to inhibit short output voltage pulses the overvoltage at the motor terminals is limited to the double DC voltage. Before you can use this function you have to check that the motor is suitable!

NOTICE

The specified lengths of motor cables are recommended limits based on typical motor cables, laying in cable channels, default pulse frequency and maximal output frequency of 100 Hz.

Available options

To enlarge the field of applications, various options are available concerning control and operation, extensions referring to the electric arrangement and to increase the protection degree.

General enclosure options

Allocation table for options

Option	Brief description	Order number	Weight [kg]	Reference
Inputs/outputs				
Basic I/O extension card	Terminal extension for additional digital inputs and outputs	VW3 A3E 201	0.320	See product catalogue
Extended I/O extension card	Terminal extension for additional analog and digital inputs and outputs	VW3 A3E 202	0.300	See product catalogue
Control terminals X12	Control terminals for the basic inverter	VW3 AE 1201	0.700	page 69
Control terminals X12, X13	Control terminals for the basic device and the I/O option cards VW3 A3E 201 and 202.	VW3 AE 1202	0.900	page 69
Adapter for 115 V logic inputs	Enables the use of 115 V logic signals.	VW3 A3E 101	0.200	See product catalogue
Relay output OC	Relay for digital output (Open collector)	VW3 AE 2201	0.100	page 70
"Controller inside" card	Programmable card for integration of control system functions.	VW3 A3E 501	0.300	See product catalogue
Additional electrical input isolation	Isolated amplifier with optoelectronic potential separation connected to the analog input of the inverter	VW3 AE 1901	0.100	page 71
Additional electrical output isolation	Isolated amplifier with optoelectronic potential separation connected to the analog output of the inverter	VW3 AE 1902	0.100	page 72
Encoder feedback				
Encoder interface card 5 V / RS422	Extension card for encoder feedback. Supply voltage 5 V / RS422	VW3 A3E 401	0.200	See product catalogue
Encoder interface card 12 V OC	Extension card for encoder feedback. Supply voltage 12 V / open collector output	VW3 A3E 403	0.200	
Encoder interface card 15 V OC	Extension card for encoder feedback. Supply voltage 15 V / open collector output	VW3 A3E 404	0.200	
Encoder interface card 12 V (push-pull)	Extension card for encoder feedback. Supply voltage 12 V / push-pull	VW3 A3E 405	0.200	
Encoder interface card 15 V (push-pull)	Extension card for encoder feedback. Supply voltage 15 V / push-pull	VW3 A3E 406	0.200	
Encoder interface card 24 V (push-pull)	Extension card for encoder feedback. Supply voltage 24 V / push-pull	VW3 A3E 407	0.200	

Allocation table for options				
Option	Brief description	Order number	Weight [kg]	Reference
Fieldbuses (industry)				
Modbus TCP Daisy Chain communication card	Option card for control of the inverter via Modbus TCP Daisy Chain.	VW3 A3E 310D	0.300	
Ethernet/IP communication card	Option card for control of the inverter via Ethernet/IP.	VW3 A3E 316	0.300	
Fipio communication card	Option card for control of the inverter via Fipio.	VW3 A3E 311	0.300	
Modbus Plus communication card	Option card for control of the inverter via Modbus plus.	VW3 A3E 302	0.300	
DeviceNet communication card	Option card for control of the inverter via DeviceNet.	VW3 A3E 309	0.300	
Interbus communication card	Option card for control of the inverter via Interbus.	VW3 A3E 304	0.300	
CC-Link communication card	Option card for control of the inverter via CC-Link.	VW3 A3E 317	0.300	
Modbus/Uni-Telway communication card	Option card for control of the inverter via Modbus/Uni-Telway.	VW3 A3E 303	0.300	
Profibus DP communication card	Option card for control of the inverter via Profibus DP.	VW3 A3E 307	0.300	
Profibus DPv1 communication card	Option card for control of the inverter via Profibus DPv1.	VW3 A3E 307 S371	0.300	
Safety - monitoring of the motor				
STO with button		VW3 AE 1501	0.100	page 76
"Preventa type AC" safety relay	This function helps to prevent any unintended start-up of the motor.	VW3 AE 1502	0.100	page 77
"Preventa type ATE" safety relay		VW3 AE 1503	0.100	page 78
PTC relay	PTC thermistor relay to monitor the PTC thermistors in the motor	VW3 AE 2001	0.100	page 73
PTC relay with PTB (ATEX) certification	PTC thermistor relay with PTB certificate to monitor the PTC thermistors in the motor in EX-environments	VW3 AE 2002	0.100	page 74
Pt100 relay for motor winding	Pt100 relay to monitor the Pt100 sensors in the motor winding	VW3 AE 2003	0.300	page 74
Pt100 relay for motor bearings	Pt100 relay to monitor the Pt100 sensors in the motor bearings	VW3 AE 2004	0.300	page 75
Pt100 relay for transformer	Pt100 relay to monitor the Pt100 sensors in the transformer	VW3 AE 2005	0.300	page 75
Further enclosure options				
Insulation monitoring	Monitors each phase to ground (earth) fault (only for IT networks)	VW3 AE 2601	5.000	page 79
Design for IT networks	The frequency inverter will be prepared for the connection to non-grounded networks (IT networks).	VW3 AE 2701	–	page 79
External 230V AC supply terminals	Provides the terminals and the protection for an external 230 V supply voltage.	VW3 AE 1301	0.100	page 80
External 24 V DC supply terminals	Provides the terminals and the protection for an external 24 V buffer voltage.	VW3 AE 1402	0.100	page 80
Enclosure lighting	Fluorescent lamp and a power socket 230V AC	VW3 AE 1601	1.500	page 81
Key switch (Local / Remote)	Key switch in the enclosure door for switching between terminals/bus and local operation	VW3 AE 1801	0.200	page 82
Motor heating	Includes a motor circuit breaker, a contactor and the terminals to connect a motor heating	VW3 AE 2101	0.200	page 81
External motor fan	Includes a motor circuit breaker, a contactor and the terminals to connect an external motor fan	VW3 AE 2102	0.200	page 82
Voltmeter 400 V	Measuring instrument built-in in the enclosure door, which indicates the line voltage.	VW3 AE 2301	0.400	page 83
Voltmeter 690 V	Measuring instrument built-in in the enclosure door, which indicates the line voltage.	VW3 AE 2303	0.400	page 83
Fan interruption	Effects an interruption of the fans.	VW3 AE 2901	0.100	page 82
Modified wiring colors for Australia	Modified wiring colors at the power cables	VW3 AE 3001	0.100	page 83

See product catalogue

Enclosure options depending on the power		
Option	Brief description	Reference
Isolating handle for switch	Enables handling without opening the enclosure door	Page 85
Circuit breaker	Provides a switching-off at overload	Page 85
Door handle for circuit breaker	Enables handling without opening the enclosure door	Page 86
Undervoltage coil 230 V	When there is no voltage at the undervoltage coil, the circuit breaker switches off.	Page 86
Undervoltage coil 110 V	When there is no voltage at the undervoltage coil, the circuit breaker switches off.	Page 87
230 V motor for circuit breaker	Remote control of the circuit breaker via control commands is possible by means of this motor drive.	Page 87
110 V motor for circuit breaker	Remote control of the circuit breaker via control commands is possible by means of this motor drive.	Page 87
Ammeter	Measuring instrument built-in in the enclosure door, which indicates the line current.	Page 88
Enclosure heater	Heats the enclosure to avoid frost and condensation up to an ambient temperature of -10°C	Page 89
Motor choke	Reduces the slew rate on the output of the inverter which helps to protect the motor	Page 90
Cable entry via the top	Allows connection of the line and the motor cables from above	Page 91
Enclosure plinth	200 mm plinth	Page 92

Allocation table for options depending on the power			
Description	ATV71	Order number	Weight [kg]
Isolating handle for switch	EXC●D75N4H, D90N4H	VW3 AE 0103	1.000
	EXC●C11N4H...C25N4H	VW3 AE 0104	2.000
	EXC●C31N4H...C50N4H	VW3 AE 0105	2.000
Circuit breaker	EXC●D75N4H, D90N4H	VW3 AE 0142	–
	EXC●C11N4H, C13N4H	VW3 AE 0146	1.400
	EXC●C16N4H, C20N4H	VW3 AE 0147	1.400
	EXC●C25N4H	VW3 AE 0148	1.400
	EXC●C31N4H, C40N4H	VW3 AE 0151	–
	EXC●C50N4H	VW3 AE 0169	–
Door handle for circuit breaker	EXC●D75N4H, D90N4H	VW3 AE 0114	1.000
	EXC●C11N4H...C25N4H	VW3 AE 0115	2.000
	EXC●C31N4H...C50N4H	VW3 AE 0116	2.000
Undervoltage coil 230 V	EXC●D75N4H...C25N4H	VW3 AE 0117	0.500
	EXC●C31N4H...C50N4H	VW3 AE 0118	0.500
Undervoltage coil 110 V	EXC●D75N4H...C25N4H	VW3 AE 0119	0.500
	EXC●C31N4H...C50N4H	VW3 AE 0120	0.500
230 V motor for circuit breaker	EXC●D75N4H, EXC●D90N4H	VW3 AE 0155	1.000
	EXC●C11N4H, C13N4H	VW3 AE 0156	1.000
	EXC●C16N4H...C25N4H	VW3 AE 0157	3.000
	EXC●C31N4H, C40N4H	VW3 AE 0159	7.000
	EXC●C50N4H	VW3 AE 0176	7.000
110 V motor for circuit breaker	EXC●D75N4H, EXC●D90N4H	VW3 AE 0161	1.000
	EXC●C11N4H, C13N4H	VW3 AE 0162	3.000
	EXC●C16N4H...C25N4H	VW3 AE 0163	3.000
	EXC●C31N4H, C40N4H	VW3 AE 0165	7.000
	EXC●C50N4H	VW3 AE 0179	7.000
Ammeter	EXC●D75N4H	VW3 AE 0404	0.200
	EXC●D90N4H...C13N4H	VW3 AE 0406	0.200
	EXC●C16N4H...C25N4H	VW3 AE 0426	0.200
	EXC●C31N4H, C40N4H	VW3 AE 0409	0.200
	EXC●C50N4H	VW3 AE 0427	0.200
Enclosure heater	EXC●D75N4H...C25N4H	VW3 AE 0501	0.500
	EXC●C31N4H...C50N4H	VW3 AE 0502	1.000

Allocation table for options depending on the power					
Description	ATV71	Order number	Weight [kg]		
Motor choke	EXC●D75N4H, D90N4H	VW3 AE 0603	17.000		
	EXC●C11N4H, C13N4H	VW3 AE 0604	35.000		
	EXC●C16N4H, C20N4H	VW3 AE 0605	64.000		
	EXC●C25N4H	VW3 AE 0606	102.000		
	EXC●C31N4H	VW3 AE 0607	192.000		
	EXC●C40N4H	VW3 AE 0609	228.000		
	EXC●C50N4H	VW3 AE 0610	234.000		
Cable entry via the top	Without motor choke	EXC●D75N4H, EXC●D90N4H	VW3 AE 0744	108.000	
		EXC●C11N4H, EXC●C13N4H	VW3 AE 0706	108.000	
		EXC●C16N4H	VW3 AE 0707	108.000	
		EXC●C20N4H, EXC●C25N4H	VW3 AE 0708	126.000	
		EXC●C31N4H	VW3 AE 0709	216.000	
		EXC●C40N4H	VW3 AE 0710	252.000	
		EXC●C50N4H	VW3 AE 0711	252.000	
	With motor choke	EXC●D75N4H, EXC●D90N4H	VW3 AE 0744	108.000	
		EXC●C11N4H, EXC●C13N4H	VW3 AE 0706	108.000	
		EXC●C16N4H	VW3 AE 0707	108.000	
		EXC●C20N4H, EXC●C25N4H	VW3 AE 0708	126.000	
		EXC●C31N4H	VW3 AE 0712	108.000	
		EXC●C40N4H	VW3 AE 0713	126.000	
		EXC●C50N4H	VW3 AE 0714	126.000	
Enclosure plinth 200 mm	Without motor choke	EXC●D75N4H, D90N4H	VW3 AE 0801	11.000	
		EXC●C11N4H, C13N4H	VW3 AE 0802	13.000	
		EXC●C16N4H	VW3 AE 0827	22.000	
		EXC●C20N4H, C25N4H	VW3 AE 0828	26.000	
		EXC●C31N4H, C40N4H	VW3 AE 0829	30.000	
		EXC●C50N4H	VW3 AE 0830	34.000	
		With motor choke	EXC●D75N4H, D90N4H	VW3 AE 0801	11.000
	EXC●C11N4H, C13N4H		VW3 AE 0802	13.000	
	EXC●C16N4H		VW3 AE 0827	22.000	
	EXC●C20N4H, C25N4H		VW3 AE 0828	26.000	
	EXC●C31N4H, C40N4H		VW3 AE 0831	39.000	
	EXC●C50N4H		VW3 AE 0832	43.000	
	Additional enclosure plinth for cable entry via the top		Without motor choke	EXC●D75N4H...C25N4H	VW3 AE 0807
		EXC●C31N4H...C50N4H		VW3 AE 0808	18.000
With motor choke		EXC●D75N4H...C25N4H	VW3 AE 0807	9.000	
		EXC●C31N4H...C50N4H	VW3 AE 0809	9.000	

Altivar 71 Plus-LH in standard enclosures for 690 V mains

The basic equipment contains:

- Frequency inverter ATV71
- Active Infeed Converter
- Clean Power Filter with integrated EMC filter
- Line filter choke
- Mains connection on main switch
- Main switch (without door handle)
- Superfast semiconductor fuses for inverter protection
- LCD operating panel for the inverter (mounted into the enclosure door)
- Terminals/bars for motor connection
- Protection degree IP23:
The power part is cooled by the internal cooling circuit, the control part is cooled by fans in the enclosure door and on the roof. Air flow through grid in the enclosure door.
- Protection degree IP54:
The power part is cooled by the internal cooling circuit, the control part is cooled by fans in the enclosure door and on the roof. Air flow through grid with filter in the enclosure door.
- Enclosure Spacial SF, color RAL 7035
- Multilingual operating instructions
- Documentation-CD-ROM with parameterization instructions, fieldbus instructions, operating and parameterizing software,...
- Enclosure layout plans consisting of circuit diagram, terminal connection table, list of materials and design drawing

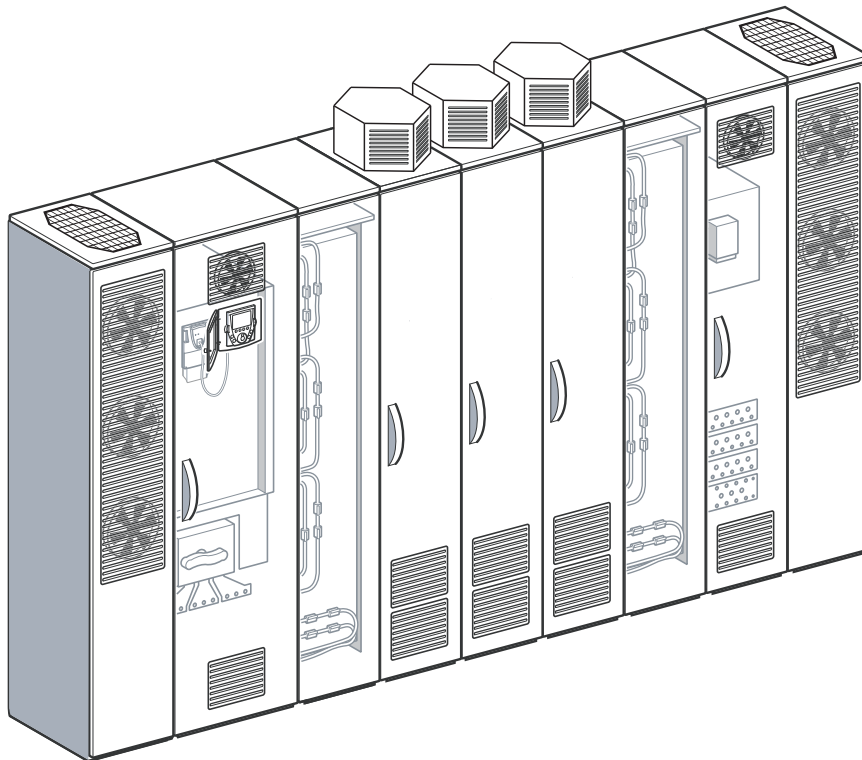

Description

Altivar 71 Plus-LH

ATV71EX●●●●●YH

Line supply voltage 690 V

General technical data	
Input	
Voltage	690 V \pm 10% for TT, TN-C, TN-S or IT networks
Frequency	50 / 60 Hz \pm 5 %
Total current distortion factor THD(i)	\leq 5 % (at nominal load on sinusoidal mains voltage)
Power factor cos phi	>0.99 (at 30...120% load)
Overvoltage class	Class III according to EN 50178
Output	
Control method	Vector-oriented flux control without feedback, V/f characteristic, energy saving system
Voltage	3 AC 0...110% mains voltage, dynamic voltage stabilization
Overload	50 % for 60 seconds per 10 minutes, 65 % for 2 seconds
Pulse frequency	2.5 kHz, adjustable from 2...4.9 kHz
Frequency / Base frequency	0.1...500 Hz / 25...500 Hz, adjustable
Short circuit protection	Short circuits and ground (earth) faults are handled by overcurrent function and switch-off the output
Design	Floor-standing enclosure
Cooling	Forced
Speed accuracy	V/f mode: slip frequency VC without feedback 0.3 x slip frequency VC with feedback: 0.01% of maximum frequency
Mechanical strength	
Mechanical vibration	According to IEC/EN 60068-2-6 1.5 mm at 3...10 Hz, 0.6 g at 10...200 Hz (3M3 according to IEC/EN 60721-3-3)
Shock	According to IEC/EN 60068-2-27 4 g for 11 ms (3M2 according to IEC/EN 60721-3-3)
Ambient conditions	
Ambient temperature	0...+40°C (-10...+40°C with enclosure heating) 3K3 according to IEC/EN 60721-3-3 Up to +50°C with derating
Storage / Transport temperature	-25...+70°C
Protection degree	selective: ATV71EXA2●●●YH ... IP23 with internal cooling circuit and fans ATV71EXA5●●●YH ... IP54 with internal cooling circuit and filter fans
Environmental class / Humidity	Class 3K3 in accordance with IEC/EN 60721-3-3 / no condensation, max. 95 % relative humidity
Altitude	Up to 1000 m, beyond power decrease of 1 % per 100 m up to 2400 m
Allowed pollution	Pollution degree: for IP23 design: pollution degree 2 according to EN 61800-5-1 for IP54 design: pollution degree 3 according to EN 61800-5-1 Chemical / mechanical classification: 3C2 and 3S2 according to EN 60721-3-3
Protection class	Class 1 according to EN 61800-5-1
Standards	
Basic standard	The devices are designed, built and tested on the basis of EN 61800-2, EN 61800-3, EN 61800-5-1 and EN 60204-1.
EMC immunity	According to EN 61800-3, 1st and 2nd environment (IEC 1000-4-2; IEC 1000-4-3; IEC 1000-4-4; IEC 1000-4-5; IEC 1000-4-6)
EMC emission	In accordance with product standard EN 61800-3, 2 nd environment, category C3
Insulation	Galvanic insulation in accordance with EN 61800-5-1 PELV (Protective Extra Low Voltage)
Standards	CE, C-Tick, Gost, ATEX

NOTICE

Frequency inverters are a product of the restricted sales according to IEC 61800-3. In a residential environment this product can cause radio frequency interferences whereupon the user can be called on to take suitable measures.

Protection degree ATV71EXA●

In order to adapt the utmost robust Altivar product line with enclosure design optimal to the individual requests of the system, these enclosure units are available in two different designs. Each solution contains a clearly specified and tested cooling system.

The standard design of the Altivar 71 Plus-LH enclosure units complies with protection degree IP23. If a higher protection degree is desired or required, there is an IP54 solution available.

Overview of standardised protection degrees

ATV71EXA2 - Standard enclosure design IP23

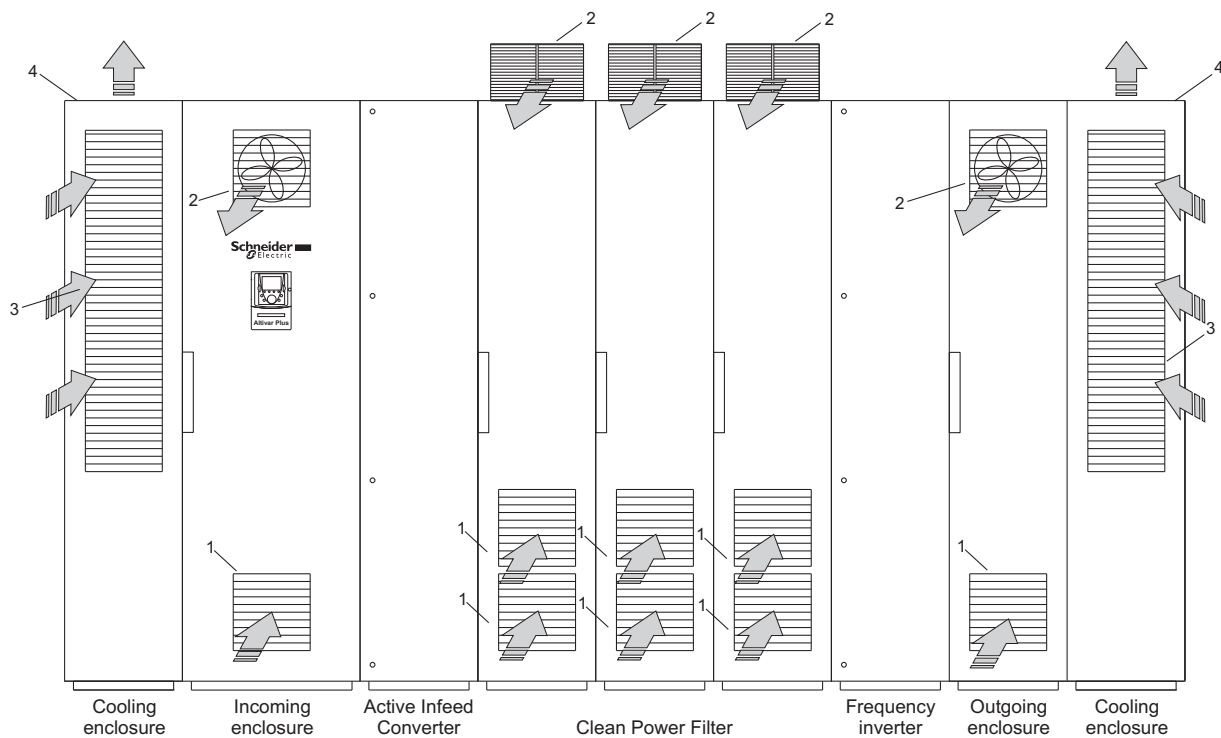

In case of this enclosure design the cooling of the power part takes place in an own enclosure. Here the cooling air is sucked in by the fans in the enclosure door and the air outlet takes place through the enclosure roof. The control part is cooled by fans in the enclosure door. At the Clean Power Filter the input of the cooling air takes place through the filters in the enclosure door and the output through the fans at the top of the enclosure.

- 1 Air inlet grid
- 2 Air outlet with fans
- 3 Air inlet grid with fans for power part
- 4 Air outlet grid for power part

Protection degree: IP23

Air inlet temperature: 0...+40°C (-10...+40°C with enclosure heating)

ATV71EXA5 - Enclosure design IP54

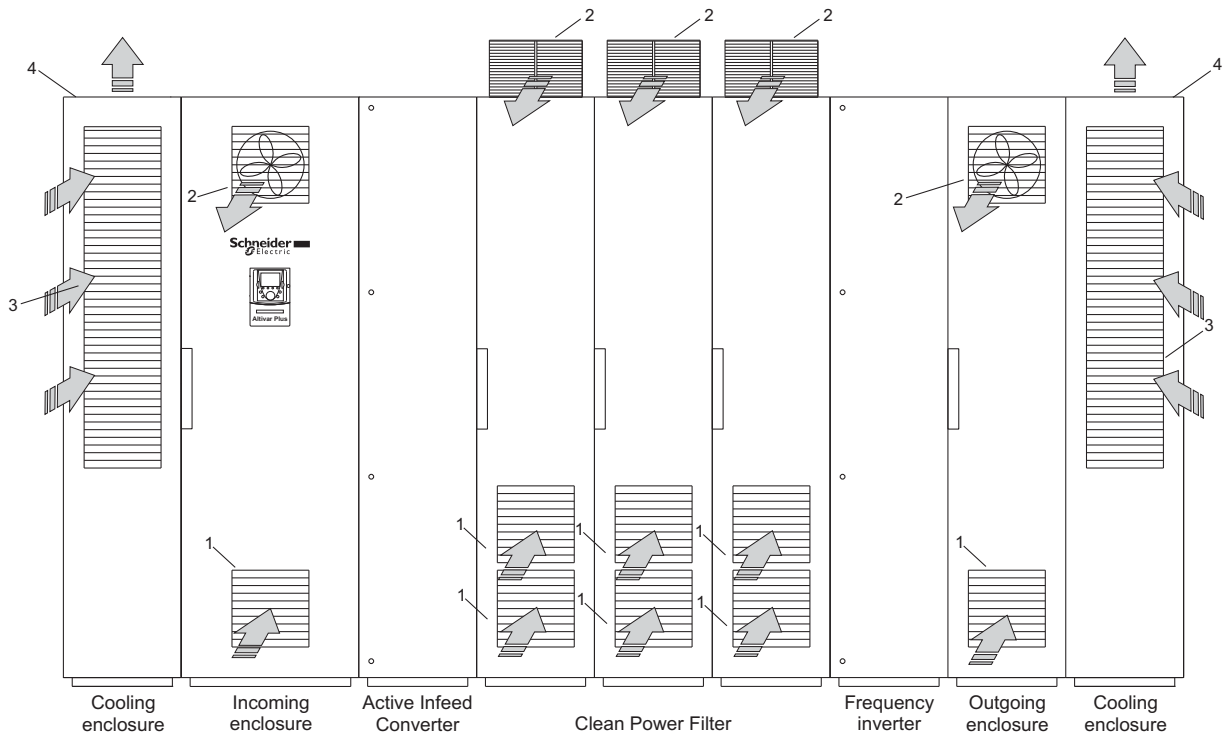

In case of this enclosure design the cooling of the power part takes place in an own enclosure. Here the cooling air is sucked in by the fans in the enclosure door and the air outlet takes place through the enclosure roof. The control part is cooled by fans in the enclosure door. At the Clean Power Filter the input of the cooling air takes place through the filters in the enclosure door and the output through the filter fans at the top of the enclosure.

- 1 Air inlet grid with filter mats
- 2 Air outlet with filter fans
- 3 Air inlet grid with fans for power part
- 4 Air outlet grid for power part

Protection degree: IP54

Air inflow temperature: 0...+40°C (-10...+40°C with enclosure heating)

Technical data				
Type		ATV71EXA● C63YH	C80YH	M10YH
Built-in AFE		1 x AIC-6C1260	1 x AIC-6C1260	1 x AIC-6C1260
Built-in inverter		ATV71EC63YE7D	ATV71EC80YE7D	ATV71EM10YE7D
Nominal data				
Motor rating				
P_N [kW]	$V_N = 690\text{ V}$	630	800	1000
Continuous output current				
I_N [A]	$V_N = 690\text{ V}$	675	840	1010
Maximum current for 60 s per 10 minutes				
I_{MAX} [A]	$V_N = 690\text{ V}$	1012	1260	1515
Input				
Input current				
I_{IN} [A]	$V_N = 690\text{ V}$	565	715	895
I_{Harm} [A] ¹⁾	$V_N = 690\text{ V}$	26.9	34	42.6
Continuous apparent power				
S_N [kVA]	$V_N = 690\text{ V}$	675	855	1070
Characteristics				
Losses [W]	at I_N	24400	30200	37000
Weight net/gross [kg]				
ATV71EXA5●●●YH		2840/2940	2840/2940	2840/2940
Ambient conditions				
Air flow [m ³ /h]		12500	12500	12500
Sound pressure level [dB(A)]		77	77	77
Mains short circuit current [kA] ²⁾		100	100	100

¹⁾ ... Value valid at sinusoidal mains voltage.

²⁾ ... Value valid for 200ms with pre-fuses, see chapter "Fuses and cable cross sections".

Dimensions: IP23CV Compact version

ATV71EXA2C63YH...M10YH

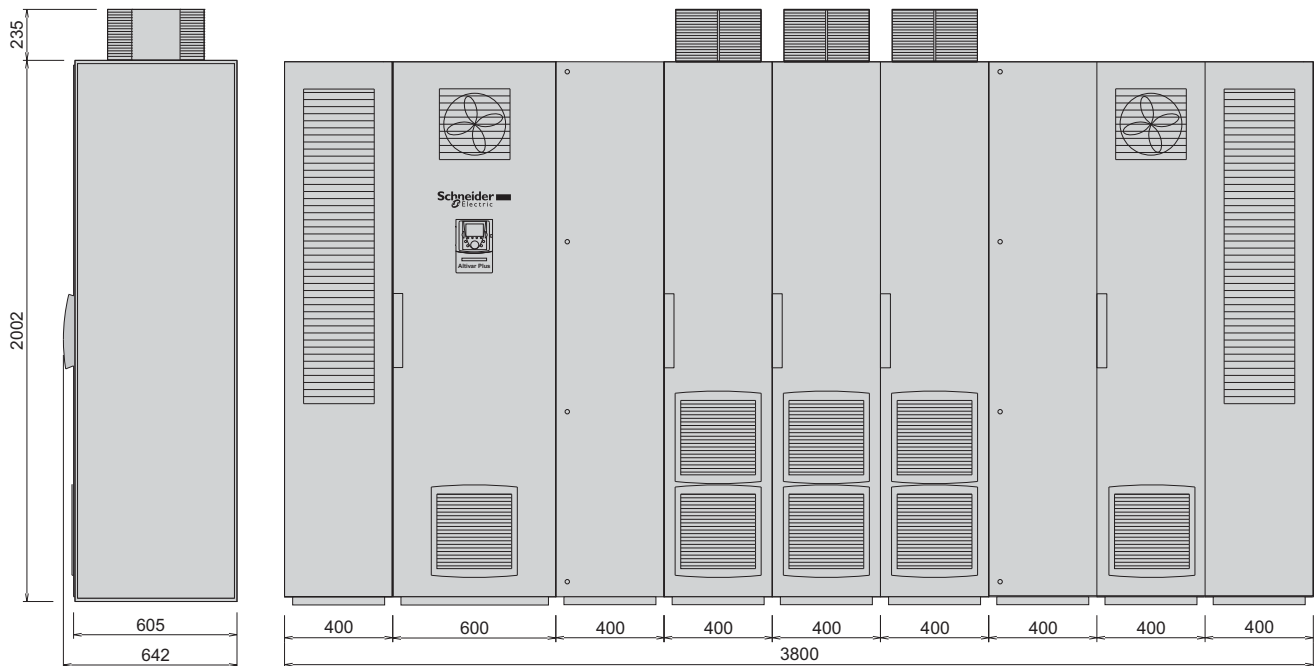

Altivar 71 Plus-LH

ATV71EX●●●●●YH

Line supply voltage 690 V

Dimensions: IP54CV Compact version

ATV71EXA5C63YH...M10YH

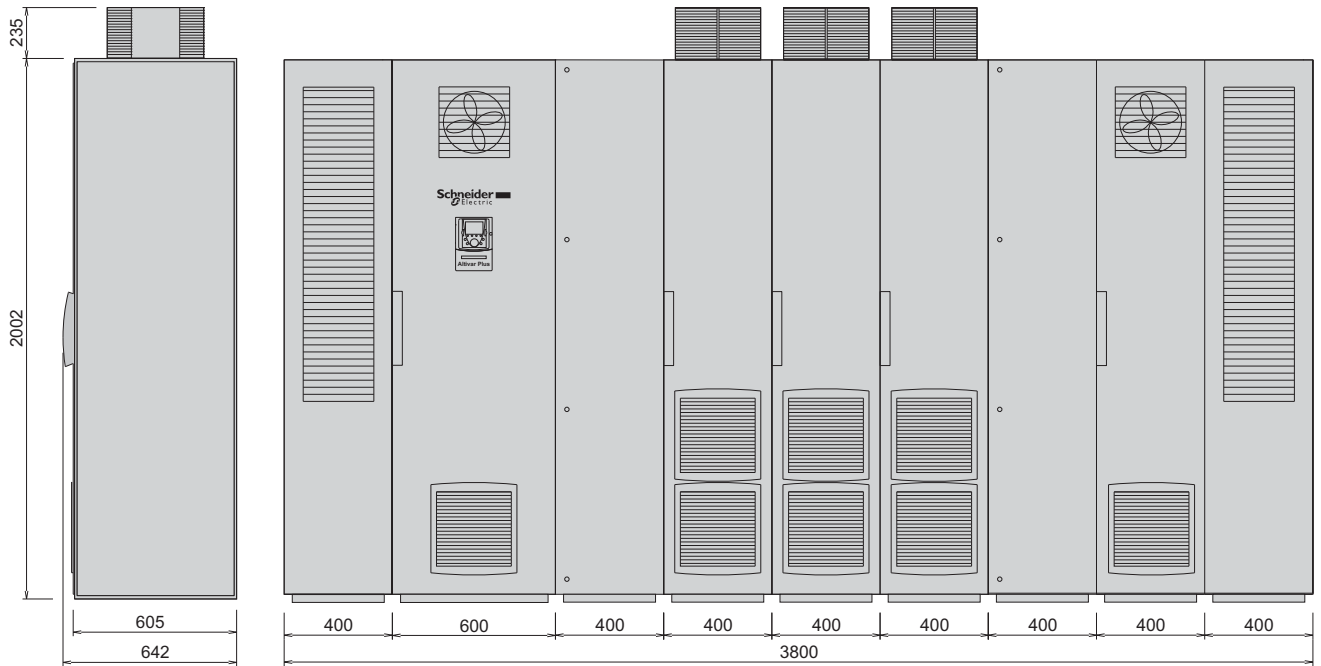

Type		ATV71EXA● M12YH	M15YH	M18YH	M20YH
Built-in AFE		2 x AIC-6C1260	2 x AIC-6C1260	2 x AIC-6C1260	2 x AIC-6C1260
Built-in inverter		ATV71EM12YE7D	ATV71EM15YE7D	ATV71EM18YE7D	ATV71EM20YE7D
Nominal data					
Motor rating					
P_N [kW]	$V_N = 690$ V	1200	1500	1800	2000
Continuous output current					
I_N [A]	$V_N = 690$ V	1260	1580	1860	2020
Maximum current for 60 s per 10 minutes					
I_{MAX} [A]	$V_N = 690$ V	1890	2370	2790	3030
Input					
Input current					
I_{IN} [A]	$V_N = 690$ V	1075	1343	1611	1791
I_{Harm} [A] ¹⁾	$V_N = 690$ V	51.2	64	76.7	85.3
Continuous apparent power					
S_N [kVA]	$V_N = 690$ V	1285	1605	1925	2140
Characteristics					
Losses [W]	at I_N	47200	58700	70000	77000
Weight net/gross [kg]					
ATV71EXA●●●●YH		5860/6060	5860/6060	5860/6060	5860/6060
Ambient conditions					
Air flow [m ³ /h]		25000	25000	25000	25000
Sound pressure level [dB(A)]		79	79	79	79
Mains short circuit current [kA] ²⁾		100	100	100	100

¹⁾ ... Value valid at sinusoidal mains voltage.

²⁾ ... Value valid for 200ms with pre-fuses, see chapter "Fuses and cable cross sections".

Dimensions: IP23CV Compact version

ATV71EXA2M12YH...M20YH

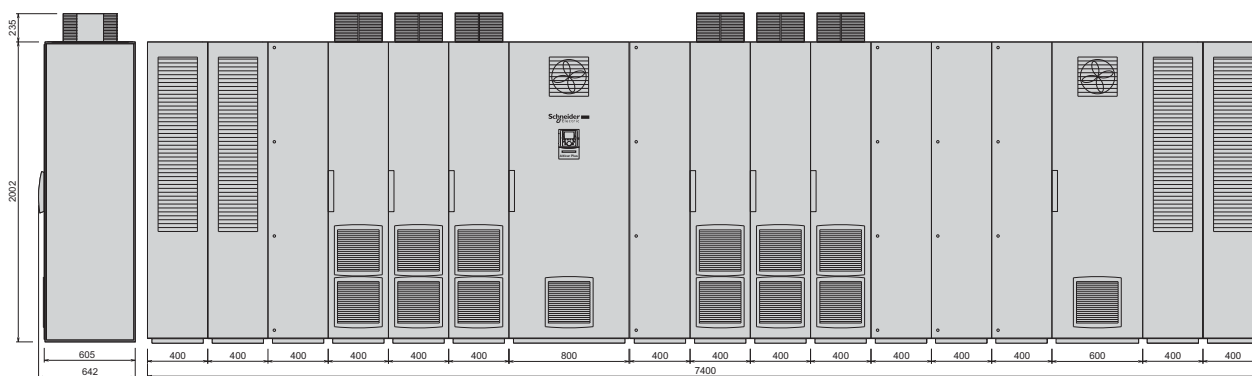

Dimensions: IP54CV Compact version

ATV71EXA5M12YH...M20YH

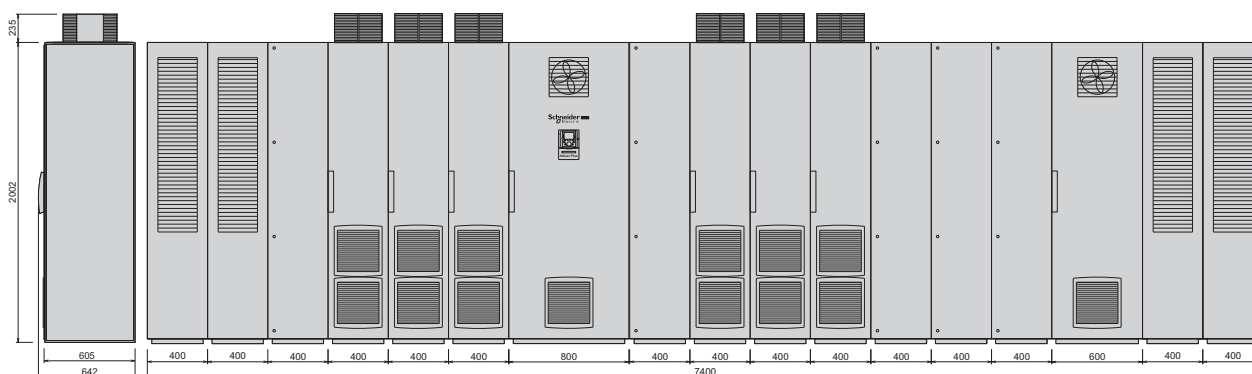

Power decrease

Depending on the chosen pulse frequency and the maximum ambient temperature a power increase is possible or a power reduction is necessary. This can be determined by means of the following diagrams.

ATV 71EXA●C63YH ... EXA●M20YH

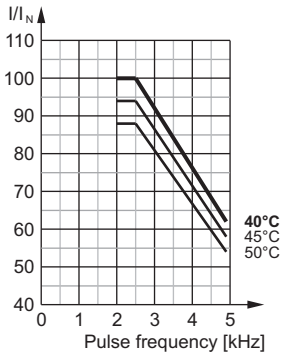

Please observe the following guidelines for operation of the drive:

- At higher pulse frequencies the allowed motor cable length is reduced (see chapter "Motor cable lengths").
- Do not select a motor which is more than one power rating bigger than the drive.

NOTICE

If the heat sink temperature is too high, the pulse frequency is automatically reduced which helps to prevent an overload of the inverter.

Fuses and cable cross sections

The Altivar enclosure designs have input fuses built-in as standard. These fuses are for the case that the electronic protective mechanism of the inverter did not work. So they are a secondary protection of the inverter.

The below-mentioned diameters for 3-wire cables are recommended values for laying the cable in air at max. 40°C ambient temperature, based on the regulations ÖVN EN 1 and VDE 0100.

The motor cables are dimensioned for the maximum continuous current. They apply to 0...100 Hz (up to 300 Hz the cable losses increase about 25 % because of the Skin-effect).

An alternative to screened (shielded) motor cables is the use of NYCY or NYCWY cables (power cables with concentric protective conductor).

DANGER

HAZARD OF ELECTRIC SHOCK, EXPLOSION, OR ARC FLASH

- In case of other ambient conditions and different regulations the cable diameters must be adjusted.
- The dimensioning of the pre-fuses, mains cable cross sections and mains cable length has to be done in observance to the available mains short circuit current to ensure a safe switch-off in case of a fault!

If required increase the power of the transformer to reach the necessary short circuit capability.

- If the mains fuses blow the inverter already has a primary defect. Therefore, exchanging the blown fuses and switching the inverter on again without any check is not effective.

Failure to follow these instructions will result in death or serious injury.

Cable cross sections at standard design

	Mains supply					Motor output		
	No. of phases	Pre-fuse (per phase)	Recommended cable [mm ²]	Max. cable [mm ²] (per phase)	Internal fuse (per phase)	Max. cable (without motor choke) [mm ²] (per phase)	Max. cable (with motor choke) [mm ²] (per phase)	Recommended cable [mm ²]
ATV71EXA● C63YH (6-pulse)	3	1000A	5x (3x 150) or 4x (3x 185)	10x 240 (M12)	3x 500 A aR	16x 240 (M12)	16x 240 (M12)	3x (3x 150)
C80YH	3	1250A	6x (3x 150) or 4x (3x 240)	10x 240 (M12)	3x 500 A aR	16x 240 (M12)	16x 240 (M12)	4x (3x 150)
M10YH	3	1600A	8x (3x 150) or 6x (3x 240)	10x 240 (M12)	3x 500 A aR	16x 240 (M12)	16x 240 (M12)	5x (3x 150)
M12YH	3	2000A	8x (3x 185)	16x 240 (M12)	6x 500 A aR	24x 240 (M12)	24x 240 (M12)	6x (3x 185) or 5x (3x 240)
M15YH	3	2500A	12x (3x 150) or 8x (3x 240)	16x 240 (M12)	6x 500 A aR	24x 240 (M12)	24x 240 (M12)	7x (3x 185) or 6x (3x 240)
M18YH	3	2500A	12x (3x 150) or 8x (3x 240)	16x 240 (M12)	6x 500 A aR	24x 240 (M12)	24x 240 (M12)	7x (3x 240)
M20YH	3	3200A	16x (3x 150) or 12x (3x 240)	16x 240 (M12)	6x 500 A aR	24x 240 (M12)	24x 240 (M12)	9x (3x 185) or 8x (3x 240)

NOTICE

Differing cable cross sections on request.

Cable cross sections at cable entry via the top									
		Mains supply				Internal fuse (per phase)	Motor output		
		No. of phases	Pre-fuse (per phase)	Recommended cable [mm ²]	Max. cable [mm ²] (per phase)		Max. cable (without motor choke) [mm ²] (per phase)	Max. cable (with motor choke) [mm ²] (per phase)	Recommended cable [mm ²]
ATV71EXA● (6-pulse)	C63YH	3	1000A	5x (3x 150) or 4x (3x 185)	10x 240 (M12)	3x 500 A aR	16x 240 (M12)	16x 240 (M12)	3x (3x 150)
	C80YH	3	1250A	6x (3x 150) or 4x (3x 240)	10x 240 (M12)	3x 500 A aR	16x 240 (M12)	16x 240 (M12)	4x (3x 150)
	M10YH	3	1600A	8x (3x 150) or 6x (3x 240)	10x 240 (M12)	3x 500 A aR	16x 240 (M12)	16x 240 (M12)	5x (3x 150)
	M12YH	3	2000A	8x (3x 185)	16x 240 (M12)	6x 500 A aR	24x 240 (M12)	24x 240 (M12)	6x (3x 185) or 5x (3x 240)
	M15YH	3	2500A	12x (3x 150) or 8x (3x 240)	16x 240 (M12)	6x 500 A aR	24x 240 (M12)	24x 240 (M12)	7x (3x 185) or 6x (3x 240)
	M18YH	3	2500A	12x (3x 150) or 8x (3x 240)	16x 240 (M12)	6x 500 A aR	24x 240 (M12)	24x 240 (M12)	7x (3x 240)
	M20YH	3	3200A	16x (3x 150) or 12x (3x 240)	16x 240 (M12)	6x 500 A aR	24x 240 (M12)	24x 240 (M12)	9x (3x 185) or 8x (3x 240)

NOTICE

Differing cable cross sections on request.

Motor cable lengths

Because of the permitted mains disturbances, the allowed overvoltages at the motor, the occurring bearing currents and the permitted losses the distance between inverter and motor(s) is limited. The maximum distance heavily depends on the type of motor cable (screened (shielded) / unscreened (unshielded)) as well as from the used options.

Overvoltages at the motor

Overvoltages at the motor terminals result from reflection in the motor cable. Basically the motors are stressed with measurable higher voltage peaks from a motor cable length of 50 m. Thereby the motor load is nearly independent from the used inverter !

Line supply voltage 690 V Motor insulation for 2000 V phase-to-phase peak voltage and dv/dt resistance > 8 kV/μs

In order to use standard motors in this voltage range, the Altivar frequency inverters have a function to inhibit short output voltage pulses. With this function the reflection conditional overvoltages are attenuated. The slew rate as well as the EMC load are not influenced by changing this parameter.

At even longer motor cables the use of a "dv/dt filter" is required. Combined with the cable capacitance the option motor choke affects like a filter and limits the voltage peaks at the motor as well as the slew rate of the output pulses.

When the specified motor cable lengths are observed the motor life time can be significantly extended:

Line supply voltage 690 V max. 1800 V phase-to-phase peak voltage and dv/dt < 1000 V/μs

CAUTION

RISK OF OVERVOLTAGE AT THE MOTOR

Observe the specified length of motor cables in order to protect the motor !

Failure to follow these instructions can result in equipment damage.

EMC interferences

The mains rectifier as well as the IGBT inverter cause high-frequent interferences which drain off more and more stronger to the ground (earth) potential with increasing motor cable length. As a result the line-conducted interferences to the mains increase. The attenuation of the line reactors is not longer sufficient and the permitted interference limits are exceeded.

NOTICE

Observing the specified length of motor cables is also necessary for compliance with the EMC limits.

Bearing currents

Common mode bearing currents are significantly reduced by use of the option motor choke.

Especially in case of big motors with middle up to high motor cable lengths the option motor choke is considerable to increase the availability of the motor.

Multiplication factors

In case of different conditions the recommended cable lengths have to be converted by means of the following factors. If several factors apply, please multiply them.

- The pulse frequency does not correspond to factory default:

at 4 kHz multiply values by 0.7

- In case of output frequencies higher than 100 Hz:

up to 200 Hz multiply values by 0.8

up to 300 Hz multiply values by 0.5

- Instead of two parallel cables one thicker cable is used: multiply values by 1.5

- In case of 6-pole motor cabling (e.g. for star/delta starting circuit): multiply values by 0.75

- In case of parallel motors with a dedicated cable to each motor the inverter values have to be converted in compliance with the number of motors. When a motor choke is used for each motor, the following values in brackets apply.

at 2 motors multiply values by 0.40 (0.80)

at 3 motors multiply values by 0.25 (0.60)

at 4 motors multiply values by 0.15 (0.40)

at 5 motors multiply values by 0.10 (0.25)

- In case of parallel motors with a common cable to all motors the inverter values have to be converted in compliance with the number of motors:

at 2 motors multiply values by 0.80

at 3 motors multiply values by 0.60

at 4 motors multiply values by 0.40

at 5 motors multiply values by 0.25

Recommended maximum lengths of motor cables in 2nd environment (industrial environment)

C3 (EN 55011 - class A group 2)

no option	15 m	screened (shielded) cable
with motor choke	50 m	screened (shielded) cable

C4 (EMC concept)

with motor choke	150 m	screened (shielded) cable
no option	30 m	unscreened (unshielded) cable
with motor choke	250 m	unscreened (unshielded) cable

NOTICE

The specified lengths of motor cables are recommended limits based on typical motor cables, laying in cable channels, default pulse frequency and maximal output frequency of 100 Hz.

Available options

To enlarge the field of applications, various options are available concerning control and operation, extensions referring to the electric arrangement and to increase the protection degree.

General enclosure options

Allocation table for options

Option	Brief description	Order number	Weight [kg]	Reference
Inputs/outputs				
Basic I/O extension card	Terminal extension for additional digital inputs and outputs	VW3 A3E 201	0.320	See product catalogue
Extended I/O extension card	Terminal extension for additional analog and digital inputs and outputs	VW3 A3E 202	0.300	See product catalogue
Control terminals X12	Control terminals for the basic inverter	VW3 AE 1201	0.700	page 69
Control terminals X12, X13	Control terminals for the basic device and the I/O option cards VW3 A3E 201 and 202.	VW3 AE 1202	0.900	page 69
Adapter for 115 V logic inputs	Enables the use of 115 V logic signals.	VW3 A3E 101	0.200	See product catalogue
Relay output OC	Relay for digital output (Open collector)	VW3 AE 2201	0.100	page 70
"Controller inside" card	Programmable card for integration of control system functions.	VW3 A3E 501	0.300	See product catalogue
Additional electrical input isolation	Isolated amplifier with optoelectronic potential separation connected to the analog input of the inverter	VW3 AE 1901	0.100	page 71
Additional electrical output isolation	Isolated amplifier with optoelectronic potential separation connected to the analog output of the inverter	VW3 AE 1902	0.100	page 72
Encoder feedback				
Encoder interface card 5 V / RS422	Extension card for encoder feedback. Supply voltage 5 V / RS422	VW3 A3E 401	0.200	See product catalogue
Encoder interface card 12 V OC	Extension card for encoder feedback. Supply voltage 12 V / open collector output	VW3 A3E 403	0.200	
Encoder interface card 15 V OC	Extension card for encoder feedback. Supply voltage 15 V / open collector output	VW3 A3E 404	0.200	
Encoder interface card 12 V (push-pull)	Extension card for encoder feedback. Supply voltage 12 V / push-pull	VW3 A3E 405	0.200	
Encoder interface card 15 V (push-pull)	Extension card for encoder feedback. Supply voltage 15 V / push-pull	VW3 A3E 406	0.200	
Encoder interface card 24 V (push-pull)	Extension card for encoder feedback. Supply voltage 24 V / push-pull	VW3 A3E 407	0.200	
Encoder interface card 24 V (push-pull)	Extension card for encoder feedback. Supply voltage 24 V / push-pull	VW3 A3E 407	0.200	

Allocation table for options				
Option	Brief description	Order number	Weight [kg]	Reference
Fieldbuses (industry)				
Modbus TCP Daisy Chain communication card	Option card for control of the inverter via Modbus TCP Daisy Chain.	VW3 A3E 310D	0.300	
Ethernet/IP communication card	Option card for control of the inverter via Ethernet/IP.	VW3 A3E 316	0.300	
Fipio communication card	Option card for control of the inverter via Fipio.	VW3 A3E 311	0.300	
Modbus Plus communication card	Option card for control of the inverter via Modbus plus.	VW3 A3E 302	0.300	
DeviceNet communication card	Option card for control of the inverter via DeviceNet.	VW3 A3E 309	0.300	
Interbus communication card	Option card for control of the inverter via Interbus.	VW3 A3E 304	0.300	
CC-Link communication card	Option card for control of the inverter via CC-Link.	VW3 A3E 317	0.300	
Modbus/Uni-Telway communication card	Option card for control of the inverter via Modbus/Uni-Telway.	VW3 A3E 303	0.300	
Profibus DP communication card	Option card for control of the inverter via Profibus DP.	VW3 A3E 307	0.300	
Profibus DPv1 communication card	Option card for control of the inverter via Profibus DPv1.	VW3 A3E 307 S371	0.300	
Safety - monitoring of the motor				
STO with button		VW3 AE 1501	0.100	page 76
"Preventa type AC" safety relay	This function helps to prevent any unintended start-up of the motor.	VW3 AE 1502	0.100	page 77
"Preventa type ATE" safety relay		VW3 AE 1503	0.100	page 78
PTC relay	PTC thermistor relay to monitor the PTC thermistors in the motor	VW3 AE 2001	0.100	page 73
PTC relay with PTB (ATEX) certification	PTC thermistor relay with PTB certificate to monitor the PTC thermistors in the motor in EX-environments	VW3 AE 2002	0.100	page 74
Pt100 relay for motor winding	Pt100 relay to monitor the Pt100 sensors in the motor winding	VW3 AE 2003	0.300	page 74
Pt100 relay for motor bearings	Pt100 relay to monitor the Pt100 sensors in the motor bearings	VW3 AE 2004	0.300	page 75
Pt100 relay for transformer	Pt100 relay to monitor the Pt100 sensors in the transformer	VW3 AE 2005	0.300	page 75
Further enclosure options				
Insulation monitoring	Monitors each phase to ground (earth) fault (only for IT networks)	VW3 AE 2601	5.000	page 79
Design for IT networks	The frequency inverter will be prepared for the connection to non-grounded networks (IT networks).	VW3 AE 2701	–	page 79
External 230V AC supply terminals	Provides the terminals and the protection for an external 230 V supply voltage.	VW3 AE 1301	0.100	page 80
External 24 V DC supply terminals	Provides the terminals and the protection for an external 24 V buffer voltage.	VW3 AE 1402	0.100	page 80
Enclosure lighting	Fluorescent lamp and a power socket 230V AC	VW3 AE 1601	1.500	page 81
Key switch (Local / Remote)	Key switch in the enclosure door for switching between terminals/bus and local operation	VW3 AE 1801	0.200	page 82
Motor heating	Includes a motor circuit breaker, a contactor and the terminals to connect a motor heating	VW3 AE 2101	0.200	page 81
External motor fan	Includes a motor circuit breaker, a contactor and the terminals to connect an external motor fan	VW3 AE 2102	0.200	page 82
Voltmeter 400 V	Measuring instrument built-in in the enclosure door, which indicates the line voltage.	VW3 AE 2301	0.400	page 83
Voltmeter 690 V	Measuring instrument built-in in the enclosure door, which indicates the line voltage.	VW3 AE 2303	0.400	page 83
Fan interruption	Effects an interruption of the fans.	VW3 AE 2901	0.100	page 82
Modified wiring colors for Australia	Modified wiring colors at the power cables	VW3 AE 3001	0.100	page 83

See product catalogue

Enclosure options depending on the power		
Option	Brief description	Reference
Isolating handle for switch	Enables handling without opening the enclosure door	Page 85
Circuit breaker	Provides a switching-off at overload	Page 85
Door handle for circuit breaker	Enables handling without opening the enclosure door	Page 86
Undervoltage coil 230 V	When there is no voltage at the undervoltage coil, the circuit breaker switches off.	Page 86
Undervoltage coil 110 V	When there is no voltage at the undervoltage coil, the circuit breaker switches off.	Page 87
230 V motor for circuit breaker	Remote control of the circuit breaker via control commands is possible by means of this motor drive.	Page 87
110 V motor for circuit breaker	Remote control of the circuit breaker via control commands is possible by means of this motor drive.	Page 87
Ammeter	Measuring instrument built-in in the enclosure door, which indicates the line current.	Page 88
Enclosure heater	Heats the enclosure to avoid frost and condensation up to an ambient temperature of -10°C	Page 89
Motor choke	Reduces the slew rate on the output of the inverter which helps to protect the motor	Page 90
Cable entry via the top	Allows connection of the line and the motor cables from above	Page 91
Enclosure plinth	200 mm plinth	Page 92

Allocation table for options depending on the power			
Description	ATV71	Order number	Weight [kg]
Isolating handle for switch	EXA●C63YH...M20YH	VW3 AE 0105	2.000
	EXA●C63YH	VW3 AE 0151	–
	EXA●C80YH	VW3 AE 0169	–
	EXA●M10YH	VW3 AE 0170	–
	EXA●M12YH	VW3 AE 0175	–
	EXA●M15YH	VW3 AE 0171	–
	EXA●M18YH	VW3 AE 0172	–
	EXA●M20YH	VW3 AE 0173	–
Door handle for circuit breaker	EXA●C63YH...M10YH	VW3 AE 0116	2.000
	EXA●M12YH...M20YH	–	–
Undervoltage coil 230 V	EXA●C63YH...M20YH	VW3 AE 0118	0.500
Undervoltage coil 110 V	EXA●C63YH...M20YH	VW3 AE 0120	0.500
230 V motor for circuit breaker	EXA●C63YH	VW3 AE 0159	7.000
	EXA●C80YH	VW3 AE 0176	7.000
	EXA●M10YH	VW3 AE 0177	7.000
	EXA●M12YH...M20YH	–	–
110 V motor for circuit breaker	EXA●C63YH	VW3 AE 0165	7.000
	EXA●C80YH	VW3 AE 0179	7.000
	EXA●M10YH	VW3 AE 0180	7.000
	EXA●M12YH...M20YH	–	–
Ammeter	EXA●C63YH	VW3 AE 0409	0.200
	EXA●C80YH	VW3 AE 0427	0.200
	EXA●M10YH	VW3 AE 0411	0.200
	EXA●M12YH	VW3 AE 0413	0.200
	EXA●M15YH, EXA●M18YH	VW3 AE 0414	0.200
	EXA●M20YH	VW3 AE 0415	0.200
Enclosure heater	EXA●C63YH...M10YH	VW3 AE 0503	1.500
	EXA●M12YH...M20YH	VW3 AE 0504	2.000
Motor choke	EXA●C63YH...M10YH	VW3 AE 0635	132.000
	EXA●M12YH...M20YH	VW3 AE 0636	264.000
Cable entry via the top	EXA●C63YH...M10YH	VW3 AE 0745	126.000
	EXA●M12YH...M20YH	VW3 AE 0746	150.000
Enclosure plinth 200 mm	EXA●C63YH...M10YH	VW3 AE 0835	83.000
	EXA●M12YH...M20YH	VW3 AE 0836	159.000
Additional enclosure plinth for cable entry via the top	EXA●C63YH...M10YH	VW3 AE 0825	9.000
	EXA●M12YH...M20YH	VW3 AE 0826	11.000

Wiring diagram

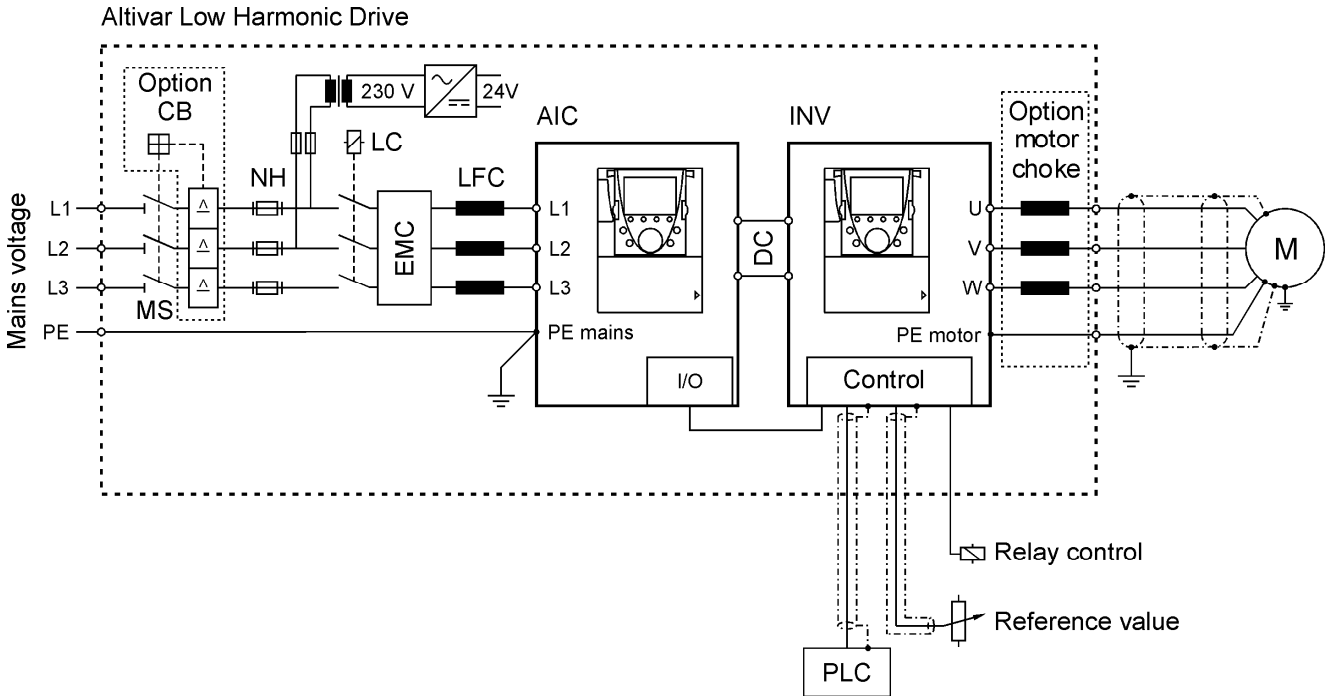

- MS..... Main switch built-in as standard
(to be used if required according to the local regulations)
- Option CB Circuit breaker
Can be installed instead of the main switch
- NH..... Main fuses built-in as standard considering table "chapter "Fuses and cable cross sections" "
- 230 V Control transformer 230 V AC
- 24 V 24 V DC power supply
- LC..... Integrated line contactor
- EMC Integrated radio frequency interference filter
considering category C3 according to EN 61800-3 "Use in industrial environments"
- LFC..... Line Filter Choke
- AIC Active Infeed Converter
- INV Inverter
- Opt. motor choke..... To reduce the voltage peaks at the motor in case of long motor cables

Standard control terminals of the Altivar 71 Plus-LH

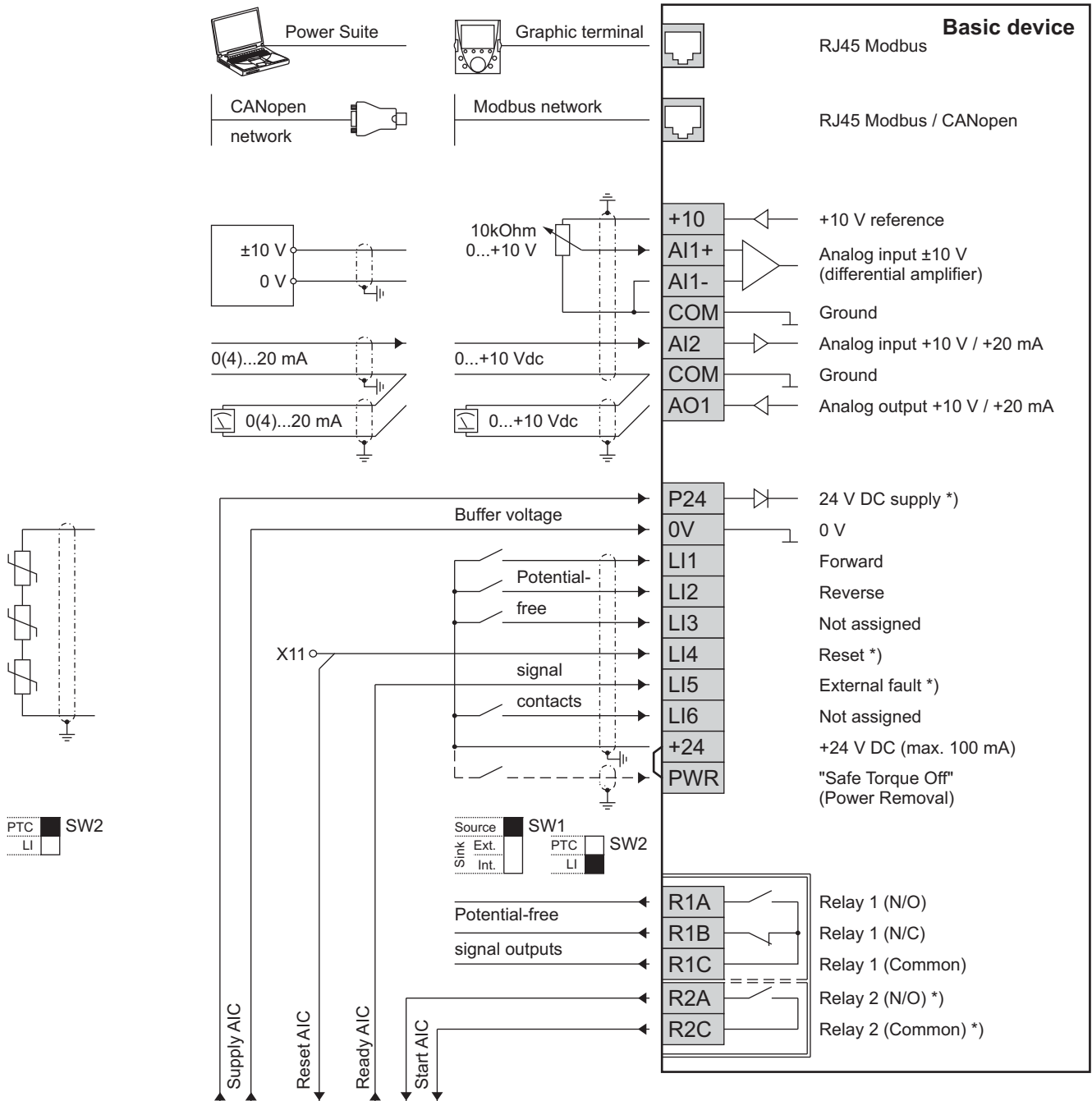

The use of the individual inputs and outputs as well as their limits can be adjusted by means of the device software. Only the alternative use of the logic input LI6 for motor thermistor monitoring and the selection of the switching method for the logic inputs has to be adjusted by means of the sliding switch.

The inverter is equipped with a built-in interface for control via Modbus. In addition to the external wiring (connection to the T-pieces in the bus line) only the adjustment of few parameters is necessary.

Alternatively, this interface can be also used for the CANopen bus. Therefore, an adapter (VW3 CAN A71) is required for conversion of the RJ45 plug to SUB-D (CANopen standard CiA DRP 303-1). The bus wiring is taken by connection to the next device.

Specifications of the standard control terminals in the inverter

Terminal	Designation	Specification
+10	Voltage supply for potentiometer 1...10 k Ω	+10 V DC (10.5 V \pm 0.5 V) max. 10 mA; short-circuit proof
AI1+ AI1-	Analog input AI1 (Usage and limits can be parameterized)	-10...+10 V DC, differential amplifier, floating up to max. 24 V *) Reaction time 2 ms \pm 0.5 ms, resolution 11 Bits + 1 sign bit, accuracy \pm 0.6 % at $\Delta\theta = 60^\circ\text{C}$ (140 $^\circ\text{F}$), linearity \pm 0.15 %
COM	Ground	0 V reference potential for analog in-/outputs
AI2	Analog input AI2 (Selection, usage and limits can be parameterized)	- 0...+10 V DC (floating up to max. 24 V), impedance 30 k Ω *) or - 0(4)...20 mA, impedance 250 Ω Reaction time 2 ms \pm 0.5 ms, resolution 11 Bits, Accuracy \pm 0.6 % at $\Delta\theta = 60^\circ\text{C}$ (140 $^\circ\text{F}$), linearity \pm 0.15 %
COM	Ground	0 V reference potential for analog in-/outputs
AO1	Analog output AO1 (Selection, usage and limits can be parameterized)	- 0...+10 V DC, load impedance 500 Ω *) or - 0(4)...20 mA, max. load impedance 500 Ω Resolution 10 Bits, reaction time 2 ms \pm 0.5 ms, accuracy \pm 1 % at $\Delta\theta = 60^\circ\text{C}$ (140 $^\circ\text{F}$), linearity \pm 0.2 %
P24	Supply buffer voltage	+24 V DC (min. 19 V, max. 30V) external supply of the control part, power demand 30 W
0 V	Ground	Reference potential of the logic inputs and 0 V of the external voltage supply P24
LI1 LI2 LI3 LI4 LI5	Logic inputs LI1...LI5 (Usage can be parameterized, Sink/Source-switching with selector switch SW1)	+24 V DC (max. 30 V), impedance 3.5 k Ω , reaction time 2 ms \pm 0.5 ms Positive logic (Source) or negative logic (Sink) compatible with Level 1 PLC Standard IEC 65A-68 SW1 at Source (factory setting): High > 11 V DC, Low < 5 V DC SW1 at Sink Int. or Sink Ext.: High < 10 V DC, Low > 16 V DC
LI6 (PTC)	Logic input LI6 or Input for PTC probe (Usage can be parameterized, Sink/Source-switching with selector switch SW2)	- <i>Selector switch SW2 at LI (factory setting):</i> Logic input LI6, same data as with LI1 up to LI5 - <i>Selector switch SW2 at PTC:</i> PTC probe, for max. 6 PTC thermistors in series *) Thermistor nominal value < 1.5 k Ω , threshold value 3 k Ω , Disengaging value 1.8 k Ω , short-circuit monitoring at < 50 Ω
+24	Sampling voltage for logic inputs (Sink/Source-switching with selector switch SW1)	- <i>Selector switch SW1 in position Source or Sink int.:</i> +24 V DC (min. 21 V, max. 27 V), short-circuit proof max. 100 mA (incl. all options) - <i>Selector switch SW1 in position Sink Ext.:</i> Input for external voltage supply +24 V DC of the logic inputs
PWR	Input of the safety function "Safe Torque Off" (Power Removal)	Logic input 24 V DC (max. 30 V) *) Impedance 1.5 k Ω , filter time 10 ms, High > 17 V, Low < 2 V If PWR is not connected to 24 V, the starting of the motor is not possible (according to the standard for functional safety EN 954-1 / ISO 13849-1, IEC / EN 61508) and IEC/EN 61800-5-2
R1A R1B R1C	Relay output 1 (R1A N.O. contact, R1B N.C. contact)	Switching capacity min. 3 mA at 24 V DC (relay as good as new) Switching capacity max. 5 A at 250 V AC (cos $\varphi = 1$) or 30 V DC, max. 2 A at 250 V AC (cos $\varphi = 0.4$) or 30 V DC (L/R = 7 ms) Reaction time 7 ms \pm 0.5 ms, life cycle 100,000 switching cycles at max. switching capacity
R2A R2C	Relay output 2 (R2A N.O. contact)	Sampling voltage has to correspond to overvoltage category II so that the PELV conditions for the remaining control terminals are fulfilled.

Maximum connection cross-section: 1.5 mm² (AWG16), 0.25 Nm (2.5 mm² (AWG14), 0.6 Nm for relay terminals)

*) Screen the wiring and lay the cables separate from the motor cable !

The maximum cable length for the PTC probe is 20 m and 15 m for the safety input PWR "Safe Torque Off".

Control terminals X12 for the basic device

The signal inputs and outputs of the frequency inverter are wired to the customer terminals X12 with plug connection (max. cable cross section: 2.5 mm²).

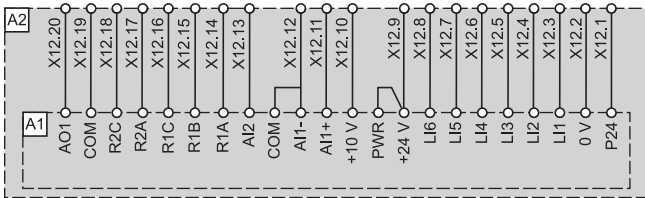

Order number: VW3 AE 1201

A1Frequency inverter ATV71

A2Enclosure

Control terminals X12 and X13 for the basic device and I/O extension cards

The signal inputs and outputs of the frequency inverter and of the option cards are wired to the customer terminals X12 and X13 with plug connection (max. cable cross section: 2.5 mm²).

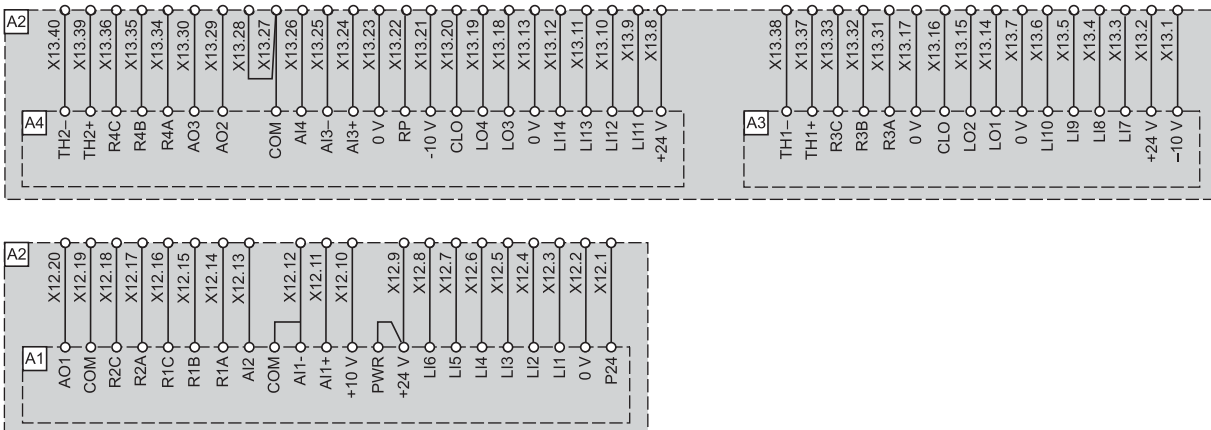

Order number: VW3 AE 1202

A1Frequency inverter ATV71

A2Enclosure

A3Basic I/O extension card

A4Extended I/O extension card

Relay output OC

This option contains a 24 V DC relay with a switching capacity of max. 6 A at 250 V AC or 30 V DC. The potential-free signal outputs are directly connected to the customer control terminals X14 (max. cable cross section: 4 mm²). The inductor is wired to the logic output of the frequency inverter. With this option each logic status information of the inverter or the process can be issued as a message by means of a logic output.

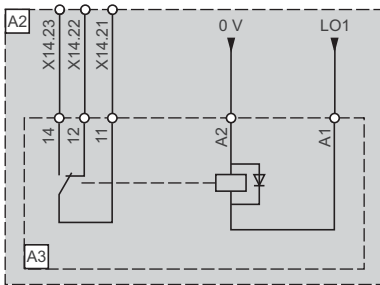

Relay output LO1

Order number: VW3 AE 2201

A2Enclosure
A3Relay

This option requires a basic I/O extension card!

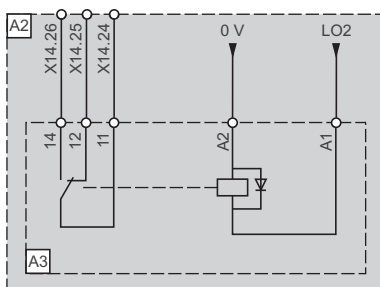

Relay output LO2

Order number: VW3 AE 2201

A2Enclosure
A3Relay

This option requires a basic I/O extension card!

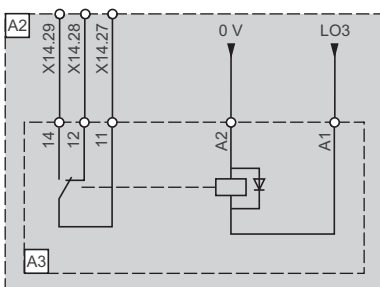

Relay output LO3

Order number: VW3 AE 2201

A2Enclosure
A3Relay

This option requires an extended I/O extension card!

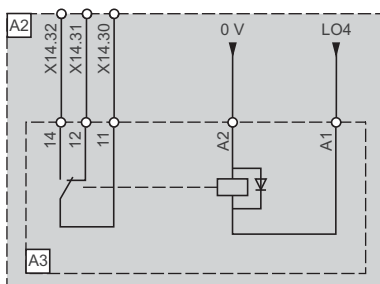

Relay output LO4

Order number: VW3 AE 2201

A2Enclosure
A3Relay

This option requires an extended I/O extension card!

Additional electrical input isolation

This option contains an isolated amplifier configured for an analog input. The signal inputs of the amplifier are directly connected to the customer control terminals X14 (max. cable cross section: 4 mm²). The output is wired to the analog input of the frequency inverter. It operates according to the principle of optoelectronic potential separation and has three-way separation between input, output and supply.

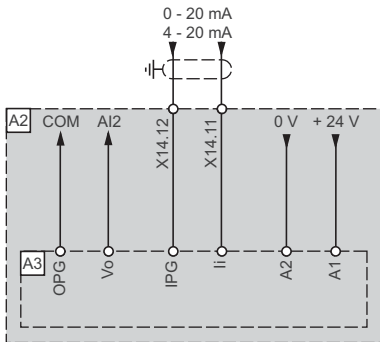

Analog input AI2

Order number: VW3 AE 1901

A2Enclosure

A3Isolated amplifier

Additional electrical output isolation

This option contains an isolated amplifier configured for an analog output. The signal outputs of the amplifier are directly connected to the customer control terminals X14 (max. cable cross section: 4 mm²). The input is wired to the analog output of the frequency inverter. It operates according to the principle of optoelectronic potential separation and has three-way separation between input, output and supply.

Analog output AO1

Order number: VW3 AE 1902

- A2Enclosure
- A3Isolated amplifier

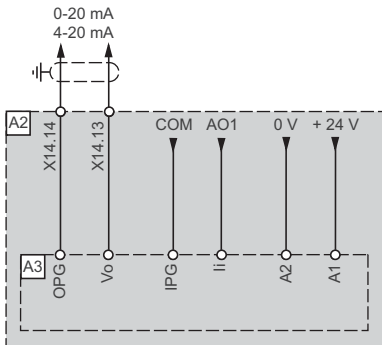

Analog output AO2

Order number: VW3 AE 1902

- A2Enclosure
- A3Isolated amplifier

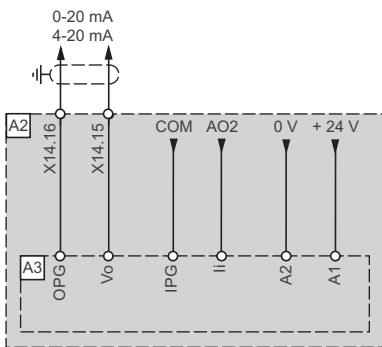

This option requires an extended I/O extension card!

Analog output AO3

Order number: VW3 AE 1902

- A2Enclosure
- A3Isolated amplifier

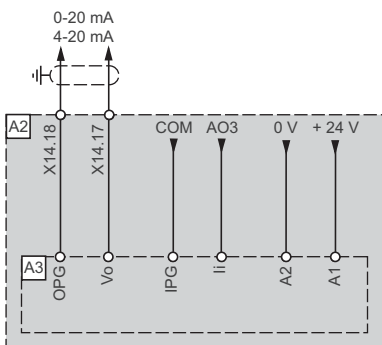

This option requires an extended I/O extension card!

PTC relay

This option consists of a PTC thermistor relay to monitor the PTC thermistors of the motor. Up to three PTC sensors can be connected to this option. The output of the PTC thermistor relay is assigned to the inverter terminals which can be parameterized for different trip messages. The thermistor input is wired to the customer terminals X03 (max. cable cross section: 4 mm²).

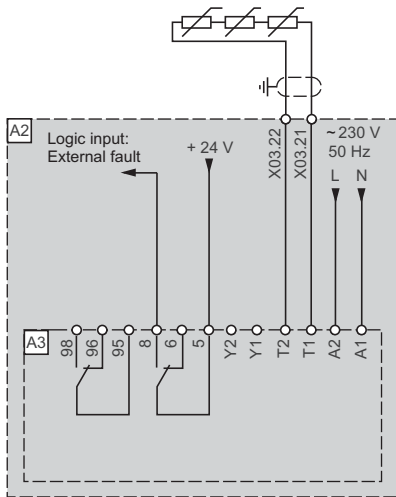

Order number: VW3 AE 2001

A2Enclosure

A3PTC relay

PTC relay with PTB (ATEX) certification

This option consists of a PTC thermistor relay with PTB certificate for operation in EX-environments to monitor the PTC thermistors of the motor. Up to three PTC sensors can be connected to this option. The output of the PTC thermistor relay is assigned to the inverter terminals (PWR). The thermistor input is wired to the customer terminals X03 (max. cable cross section: 4 mm²).

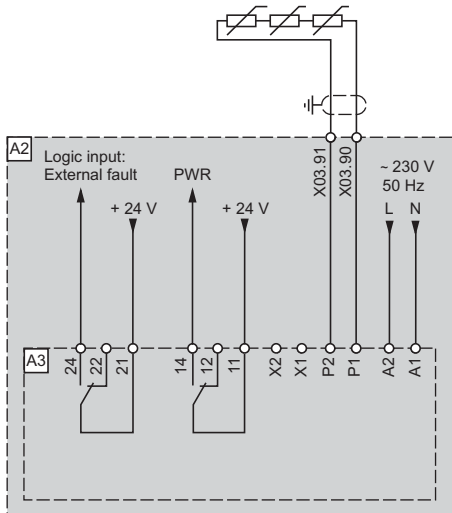

Order number: VW3 AE 2002

A2Enclosure

A3PTC relay

Pt100 relay

Pt100 sensors in motor winding

This option contains a Pt100 relay to monitor the Pt100 sensors of the motor. As standard it is prepared for three sensors for the windings. The alarm message is assigned to the terminals and the trip will cause a trip shut-down at the inverter. The input for the sensors, the alarm relay and the analog output are wired to the customer terminals X03 (max. cable cross section: 4 mm²).

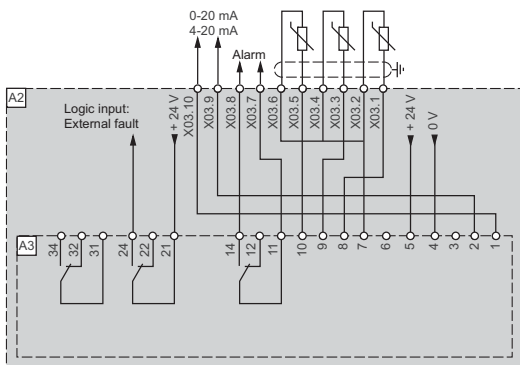

Order number: VW3 AE 2003

A2Enclosure

A3Pt100 relay

Pt100 sensors in bearings

This option contains a Pt100 relay to monitor the Pt100 sensors of the motor. As standard it is prepared for two sensors for the bearings. The alarm message is assigned to the terminals and the trip will cause a trip shut-down at the inverter. The input for the sensors, the alarm relay and the analog output are wired to the customer terminals X03 (max. cable cross section: 4 mm²).

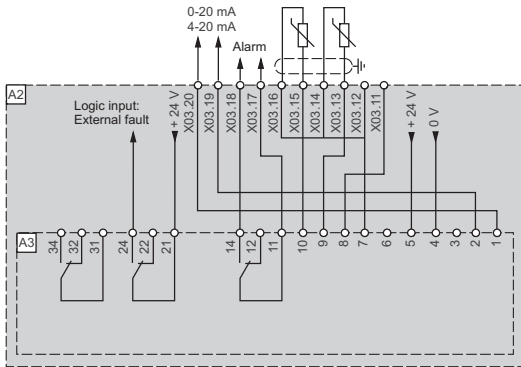

Order number: VW3 AE 2004

- A2Enclosure
- A3Pt100 relay

Pt100 sensors in the transformer

This option contains a Pt100 relay to monitor the Pt100 sensors in the transformer. As standard it is prepared for three sensors for the windings. The alarm message is assigned to the terminals and the trip will cause a trip shut-down at the inverter. The input for the sensors, the alarm relay and the analog output are wired to the customer terminals X03 (max. cable cross section: 4 mm²).

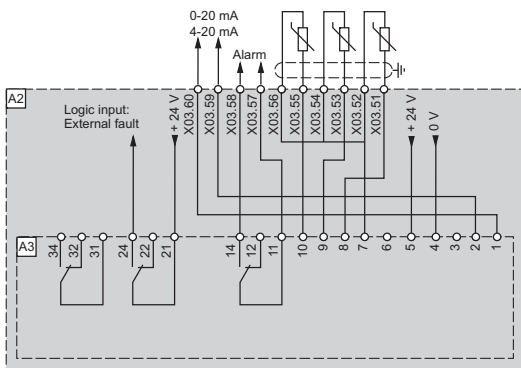

Order number: VW3 AE 2005

- A2Enclosure
- A3Pt100 relay

Safe Torque Off (STO)

The ATV71 devices include the standard protective function "Safe Torque Off STO" (Power Removal), which helps to prevent any unintended start-up of the motor. This function is wired to the customer terminals X11 (max. cable cross section: 4 mm²).

Standard	Input	ATV71EXC● D75N4H	ATV71EXC● D90N4H...C11N4H	ATV71EXC● C13N4H...C50N4H	ATV71EXC● C63YH...M20YH
IEC 61508 Ed.2	SFF	91%	91%	91%	92%
	PFH	1 E-8 h ⁻¹	1 E-8 h ⁻¹	1 E-8 h ⁻¹	1 E-8 h ⁻¹
	Type	B	B	B	B
	HFT	1	1	1	1
	DC avg	68.30 %	71.20 %	69.70 %	69.70 %
	SIL capability	2	2	2	2
IEC 62061 (1)	SIL CL capability	2	2	2	2
ISO 13849-1 (3)	PL	d	d	d	d
	Category	3	3	3	3
	MTTFd in years	1900	1750	1850	1850

Standard	Input	Emergency stop button	Preventa XPS-AC5121	Preventa XPS-ATE5110
IEC 61508 Ed.2	PFH	2.47 E-8 h ⁻¹	3.56 E-8 h ⁻¹	1.96 E-8 h ⁻¹
	DC avg	99 %	–	–
ISO 13849-1 (3)	PL	e	e	d
	Category	4	4	3
	MTTFd in years	236742	6336	6336

Performance level PL c according to ISO 13849-1
 Safety integrity level SIL 1 according to IEC/EN 61508
 Stop category 0 according to IEC/EN 60204-1

Emergency stop button

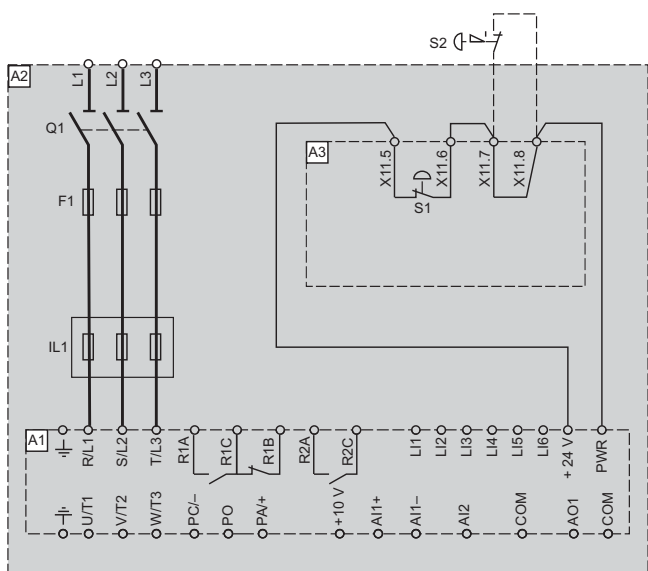

Order number: VW3 AE 1501

- A1Frequency inverter ATV71
- A2Enclosure
- A3Emergency stop wiring
- S1Emergency stop button consisting of
 Mushroom head pushbutton
 (Harmony style 4: ZB4 BS54)
 Auxiliary contact
 (Harmony style 4: ZB4 BZ102)

Insulation monitoring for IT networks

This option monitors each phase to ground (earth) fault.
This option is only qualified for IT networks.

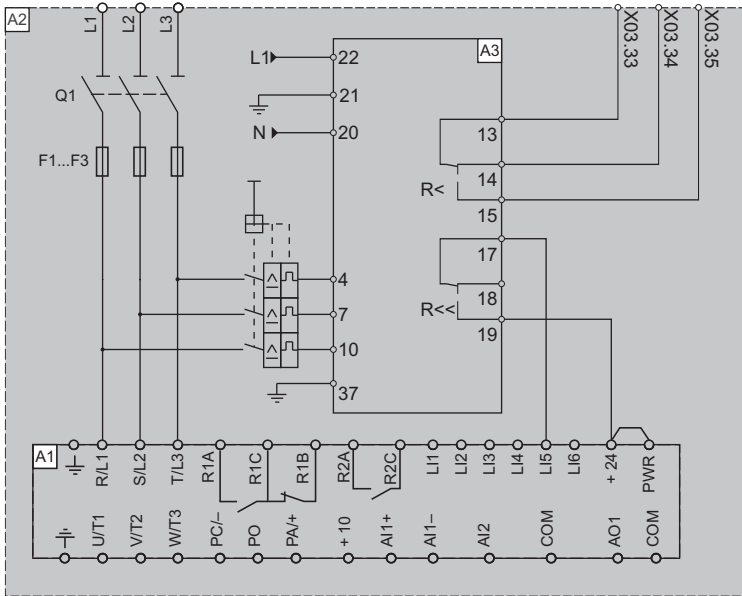

- A1 Frequency inverter ATV71
- A2 Enclosure
- A3 Isolation monitoring device

Order number: VW3 AE 2601

The trigger R<< is connected to the inverter as standard.
The alarm message R< is wired to the terminals (X3.33 to X3.35).

Design for IT networks

The frequency inverter is prepared for connection to nongrounded networks (IT networks).

Order number: VW3 AE 2701

Supply voltage 230 V AC

The ATV71 Plus-LH already includes a control transformer for 230 V as standard.

When the control voltage is provided external, the option "external supply voltage" has to be selected.

Option external supply terminals

This option includes customer terminals X11 (max. cable cross section: 4 mm²) for the connection of an external supply voltage and a circuit breaker with 6 A for protection. The external supply voltage has to be dimensioned for a load from 225 up to 800 VA, depending on the used 230 V options.

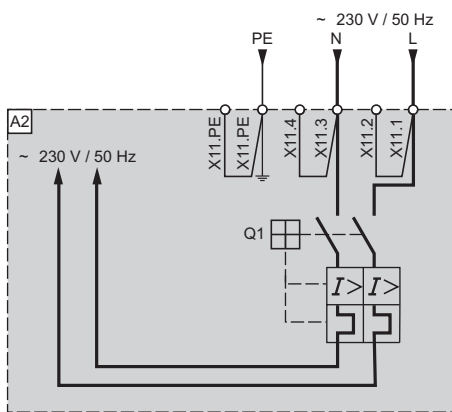

Order number: VW3 AE 1301

- A2Enclosure
- Q1Circuit breaker 6A
- X11.....Customer terminals

External 24 V DC supply terminals

The ATV71 Plus-LH already includes a 24 V DC power supply as standard.

When the 24 V DC voltage is provided external, the option "external 24 V DC supply terminals" has to be selected.

This option includes customer terminals X14 (max. cable cross section: 4 mm²) for the connection of an external buffer voltage (min. 2 A) and a circuit breaker with 2 A for protection.

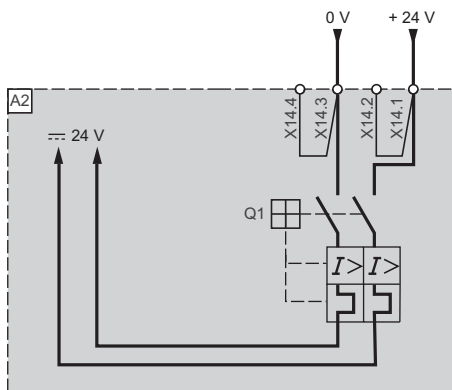

Order number: VW3 AE 1402

- A2Enclosure
- Q1Circuit breaker 2A
- X14.....Customer terminals

Enclosure lighting

This option contains a fluorescent lamp and a power socket according to VDE standard (230 V / 50 Hz), a door contact switch and a circuit breaker. The option is wired to the customer terminals X04 (max. cable cross section: 4 mm²).

NOTICE

This option requires an additional external 230 V supply (min. 1500 VA)! This supply has to fulfill the personal safety requirements!

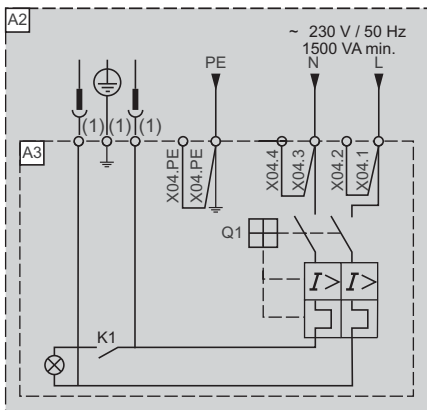

Order number: VW3 AE 1601

- A2Enclosure
- A3Enclosure lamp
- K1Door contact
- Q1Circuit breaker 2A

Motor heating

This option includes the terminals and a contactor for an external motor heating. It allows to connect a motor heater up to 200 W. The output is wired to the customer terminals X03 (max. cable cross section: 4 mm²). The activation takes place by the line contactor or by the inverter. The motor heating is active when the inverter is in off-state.

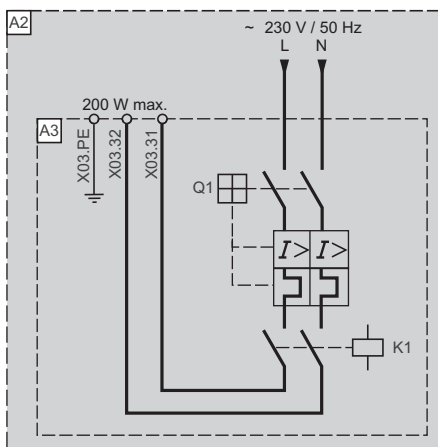

Order number: VW3 AE 2101

- A2Enclosure
- A3Motor heater
- K1Contactor
- Q1Motor circuit breaker

External motor fan

This option includes the terminals, a contactor and a circuit breaker for an external motor fan. It allows to connect an external motor fan up to 1000 W. The output is wired to the customer terminals X03 (max. cable cross section: 4 mm²). The activation takes place by the line contactor or by the inverter. The external motor fan is active when the inverter is in operation.

NOTICE

For this option the mains voltage and the voltage of the external fan has to be identical. Different voltages on request.

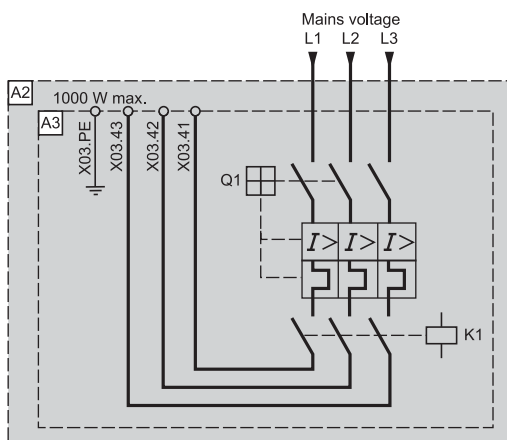

Order number: VW3 AE 2102

- A2Enclosure
- A3Option external motor fan
- K1Contactor
- Q1Motor circuit breaker

Fan interruption

This function effects an interruption of the fans. This shutdown takes place after a preset time (T = 1 min) as soon as the inverter is not in operation. So the life cycle of the fans is significantly increased and the pollution of the filter mats is reduced.

Order number: VW3 AE 2901

NOTICE

This option requires a 230 V AC supply. See chapter "Supply voltage 230 V AC", page 80 for further information.

Key switch „local / remote“

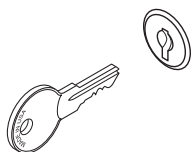

This option includes a key switch built-in the enclosure door, which switches between remote mode (terminals or bus) and panel mode. The panel control of the device occurs by means of the keys on the built-in LED-keypad or the removable operation panel, which is also built-in the enclosure door.

Order number: VW3 AE 1801

Voltmeter „Line voltage“

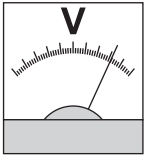

This option indicates the line voltage. It includes a measuring instrument built-in into the enclosure door and a phase selection switch.

HINWEIS

Also in case of 12-pulse supply only one voltmeter is built-in. If two instruments are desired, you have to order two instruments.

Order number:

- Supply voltage 400 V VW3 AE 2301
- Supply voltage 690 V VW3 AE 2303

Modified wiring colors for Australia

This option contains modified wiring colors and red, white and blue heat shrink tubes at the power cables.

Order number: VW3 AE 3001

Isolating handle for switch

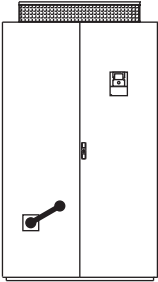

The main switch is able to switch the supply voltage of the frequency inverter. The external door handle enables handling of the switch without opening the enclosure door.

The main switch is built-in as standard. This option contains only an extended spindle for the door handle.

Allocation table

Description		ATV71	Order number	Weight [kg]
Isolating handle for switch	400 V	EXC•D75N4H, D90N4H	VW3 AE 0103	1.000
		EXC•C11N4H...C25N4H	VW3 AE 0104	2.000
		EXC•C31N4H...C50N4H	VW3 AE 0105	2.000
	690 V	EXA•C63YH...M20YH	VW3 AE 0105	2.000

Circuit breaker

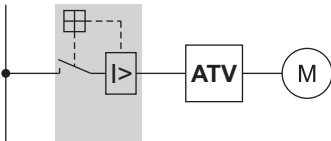

The circuit breaker is built-in instead of the main switch. It provides a switching-off at overload.

NOTICE

With a circuit breaker mains short circuit currents up to 100 kA are possible.

Allocation table

Description		ATV71	Order number	Weight [kg]
Circuit breaker	400 V	EXC•D75N4H, D90N4H	VW3 AE 0142	–
		EXC•C11N4H, C13N4H	VW3 AE 0146	1.400
		EXC•C16N4H, C20N4H	VW3 AE 0147	1.400
		EXC•C25N4H	VW3 AE 0148	1.400
		EXC•C31N4H, C40N4H	VW3 AE 0151	–
		EXC•C50N4H	VW3 AE 0169	–
	690 V	EXA•C63YH	VW3 AE 0151	–
		EXA•C80YH	VW3 AE 0169	–
		EXA•M10YH	VW3 AE 0170	–
		EXA•M12YH	VW3 AE 0175	–
		EXA•M15YH	VW3 AE 0171	–
		EXA•M18YH	VW3 AE 0172	–
		EXA•M20YH	VW3 AE 0173	–

Door handle for circuit breaker

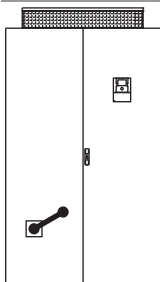

The external door handle enables handling of the switch without opening the enclosure door.

Allocation table

Description		ATV71	Order number	Weight [kg]
Door handle for circuit breaker	400 V	EXC•D75N4H, D90N4H	VW3 AE 0114	1.000
		EXC•C11N4H...C25N4H	VW3 AE 0115	2.000
		EXC•C31N4H...C50N4H	VW3 AE 0116	2.000
	690 V	EXA•C63YH...M10YH	VW3 AE 0116	2.000
		EXA•M12YH...M20YH	–	–

Undervoltage coil 230V

When there is no voltage at the undervoltage coil, the circuit breaker switches off.

Allocation table

Description		ATV71	Order number	Weight [kg]
Undervoltage coil 230V	400 V	EXC•D75N4H...C25N4H	VW3 AE 0117	0.500
		EXC•C31N4H...C50N4H	VW3 AE 0118	0.500
	690 V	EXA•C63YH...M20YH	VW3 AE 0118	0.500

Undervoltage coil 110V

When there is no voltage at the undervoltage coil, the circuit breaker switches off.

Allocation table

Description		ATV71	Order number	Weight [kg]
Undervoltage coil 110V	400 V	EXC●D75N4H...C25N4H	VW3 AE 0119	0.500
		EXC●C31N4H...C50N4H	VW3 AE 0120	0.500
	690 V	EXA●C63YH...M20YH	VW3 AE 0120	0.500

230V motor for circuit breaker

Remote control of the circuit breaker via control commands is possible by means of this motor drive.

Allocation table

Description		ATV71	Order number	Weight [kg]
230 V motor for circuit breaker	400 V	EXC●D75N4H, EXC●D90N4H	VW3 AE 0155	1.000
		EXC●C11N4H, C13N4H	VW3 AE 0156	1.000
		EXC●C16N4H...C25N4H	VW3 AE 0157	3.000
		EXC●C31N4H, C40N4H	VW3 AE 0159	7.000
		EXC●C50N4H	VW3 AE 0176	7.000
	690 V	EXA●C63YH	VW3 AE 0159	7.000
		EXA●C80YH	VW3 AE 0176	7.000
		EXA●M10YH	VW3 AE 0177	7.000
		EXA●M12YH...M20YH	–	–

110V motor for circuit breaker

Remote control of the circuit breaker via control commands is possible by means of this motor drive.

Allocation table

Description		ATV71	Order number	Weight [kg]
110 V motor for circuit breaker	400 V	EXC●D75N4H, EXC●D90N4H	VW3 AE 0161	1.000
		EXC●C11N4H, C13N4H	VW3 AE 0162	3.000
		EXC●C16N4H...C25N4H	VW3 AE 0163	3.000
		EXC●C31N4H, C40N4H	VW3 AE 0165	7.000
		EXC●C50N4H	VW3 AE 0179	7.000
	690 V	EXA●C63YH	VW3 AE 0165	7.000
		EXA●C80YH	VW3 AE 0179	7.000
		EXA●M10YH	VW3 AE 0180	7.000
		EXA●M12YH...EXA●M20YH	–	–

Amperemeter „Line current“

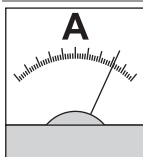

This option indicates the line current. It includes a measuring instrument built-in into the enclosure door and a current transformer.

Allocation table

Description		ATV71	Order number	Weight [kg]
Ammeter	400 V	EXC•D75N4H	VW3 AE 0404	0.200
		EXC•D90N4H...C13N4H	VW3 AE 0406	0.200
		EXC•C16N4H...C25N4H	VW3 AE 0426	0.200
		EXC•C31N4H, C40N4H	VW3 AE 0409	0.200
		EXC•C50N4H	VW3 AE 0427	0.200
		690 V	EXA•C63YH	VW3 AE 0409
	EXA•C80YH	VW3 AE 0427	0.200	
	EXA•M10YH	VW3 AE 0411	0.200	
	EXA•M12YH	VW3 AE 0413	0.200	
	EXA•M15YH, EXA•M18YH	VW3 AE 0414	0.200	
	EXA•M20YH	VW3 AE 0415	0.200	

Cubicle heating

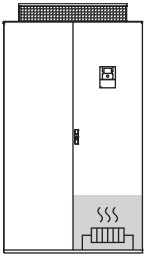

This option is used to heat the enclosure in order to avoid frost and condensation up to an ambient temperature of -10°C . It includes the enclosure heating, a thermostat and a circuit breaker. The option is wired to the customer terminals X04 (max. cable cross section: 4 mm^2).

NOTICE

This option requires an additional external 230 V supply (500...1500 VA, depending on the option)! This supply has to fulfill personal safety requirements.

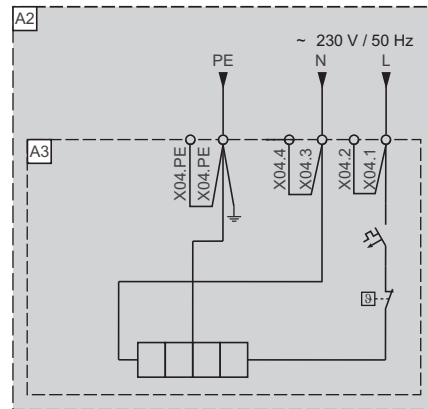

Allocation table

Description	ATV71	Order number	Weight [kg]	
Enclosure heater	400 V	EXC•D75N4H...C25N4H	VW3 AE 0501	0.500
		EXC•C31N4H...C50N4H	VW3 AE 0502	1.000
Enclosure heater	690 V	EXA•C63YH...M10YH	VW3 AE 0503	1.500
		EXA•M12YH...M20YH	VW3 AE 0504	2.000

Motor choke

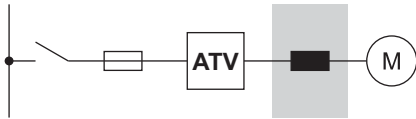

At the output of a voltage source frequency inverter there is a pulsed voltage with a pulse frequency of 2...16 kHz (ATV71EX●●●●●N, Y: 2...6 kHz) and a slew rate of more than 10 kV/μs.

The use of the option motor choke has significant advantages concerning the operation of the drive:

- Decrease of the voltage load of the motor –recommended from 50 m, necessary from 100 m for 400 V mains supply
- Prevention of common mode bearing currents in the motor – especially important at high power
- Great reduction of the influences to other cables – important if the separate laying of motor cables cannot be done

By means of the especially developed system the voltage drop at the motor choke is negligible small.

Allocation table

Description		ATV71	Order number	Weight [kg]
Motor choke	400 V	EXC●D75N4H, D90N4H	VW3 AE 0603	17.000
		EXC●C11N4H, C13N4H	VW3 AE 0604	35.000
		EXC●C16N4H, C20N4H	VW3 AE 0605	64.000
		EXC●C25N4H	VW3 AE 0606	102.000
		EXC●C31N4H	VW3 AE 0607	192.000
		EXC●C40N4H	VW3 AE 0609	228.000
		EXC●C50N4H	VW3 AE 0610	234.000
	690 V	EXA●C63YH...M10YH	VW3 AE 0635	132.000
		EXA●M12YH...M20YH	VW3 AE 0636	264.000

Cable entry above

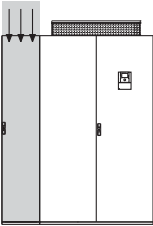

This option allows the connection of the mains and motor cables from the top of the enclosure.

NOTICE

For the width of the enclosure in combination with the cable entry via top check out the table in chapter "Width of the cubicle", page 94.

Allocation table

Description		ATV71	Order number	Weight [kg]	
Cable entry via the top	400 V	Without motor choke	EXC●D75N4H, EXC●D90N4H	VW3 AE 0744	108.000
			EXC●C11N4H, EXC●C13N4H	VW3 AE 0706	108.000
			EXC●C16N4H	VW3 AE 0707	108.000
			EXC●C20N4H, EXC●C25N4H	VW3 AE 0708	126.000
			EXC●C31N4H	VW3 AE 0709	216.000
			EXC●C40N4H	VW3 AE 0710	252.000
		EXC●C50N4H	VW3 AE 0711	252.000	
		With motor choke	EXC●D75N4H, EXC●D90N4H	VW3 AE 0744	108.000
			EXC●C11N4H, EXC●C13N4H	VW3 AE 0706	108.000
			EXC●C16N4H	VW3 AE 0707	108.000
			EXC●C20N4H, EXC●C25N4H	VW3 AE 0708	126.000
			EXC●C31N4H	VW3 AE 0712	108.000
	EXC●C40N4H		VW3 AE 0713	126.000	
	EXC●C50N4H	VW3 AE 0714	126.000		
	690 V		EXA●C63YH...M10YH	VW3 AE 0745	126.000
			EXA●M12YH...M20YH	VW3 AE 0746	150.000

Cubicle plinth 200 mm

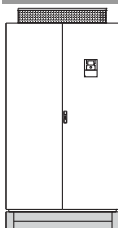

There are different additional plinths for the Altivar in IP23 or IP54 design available. Which plinth is necessary depends on the built-in options. Check out the allocation table below. The height of the enclosure will increase of 200 mm.

Allocation table

Description			ATV71	Order number	Weight [kg]
Enclosure plinth	400 V	Without motor choke	EXC•D75N4H, D90N4H	VW3 AE 0801	11.000
			EXC•C11N4H, C13N4H	VW3 AE 0802	13.000
			EXC•C16N4H	VW3 AE 0827	22.000
			EXC•C20N4H, C25N4H	VW3 AE 0828	26.000
			EXC•C31N4H, C40N4H	VW3 AE 0829	30.000
			EXC•C50N4H	VW3 AE 0830	34.000
			With motor choke	EXC•D75N4H, D90N4H	VW3 AE 0801
	EXC•C11N4H, C13N4H	VW3 AE 0802		13.000	
	EXC•C16N4H	VW3 AE 0827		22.000	
	EXC•C20N4H, C25N4H	VW3 AE 0828		26.000	
	EXC•C31N4H, C40N4H	VW3 AE 0831		39.000	
	EXC•C50N4H	VW3 AE 0832		43.000	
	690 V	EXA•C63YH...M10YH		VW3 AE 0835	83.000
		EXA•M12YH...M20YH	VW3 AE 0836	159.000	
Additional enclosure plinth for cable entry via the top	400 V	Without motor choke	EXC•D75N4H...C25N4H	VW3 AE 0807	9.000
			EXC•C31N4H...C50N4H	VW3 AE 0808	18.000
			With motor choke	EXC•D75N4H...C25N4H	VW3 AE 0807
	EXC•C31N4H...C50N4H	VW3 AE 0809		9.000	
	690 V	EXA•C63YH...M10YH	VW3 AE 0825	9.000	
		EXA•M12YH...M20YH	VW3 AE 0826	11.000	

*Cubicle options
(depending on power)*

Altivar 71 Plus-LH
Options

The following tables specify the width of the enclosure that depends on the protection degree and the options used.

Protection degree IP23 / IP54

Side view Basic device Basic device incl. options

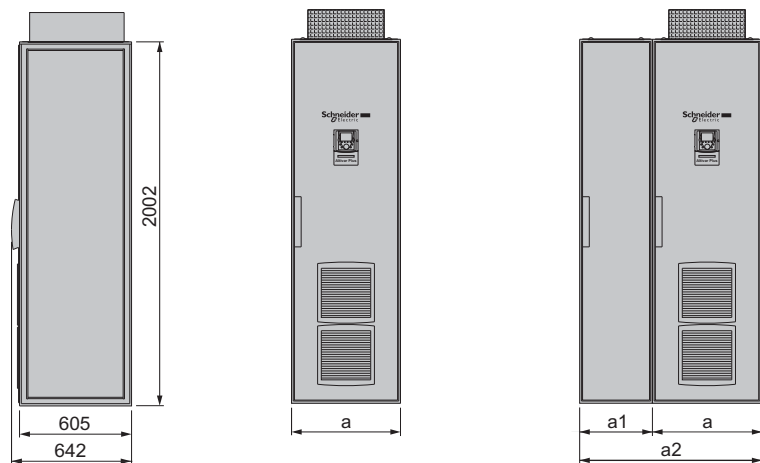

ATV71	Option	a	a1	a2
EXC•D75N4H, EXC•D90N4H	With or without general options or options depending on the power	600	–	600
	Cable entry via the top	600	400	1000
EXC•C11N4H, EXC•C13N4H	With or without general options or options depending on the power	800	–	800
	Cable entry via the top	800	400	1200

Protection degree IP23 / IP54

Side view Basic device Basic device incl. options

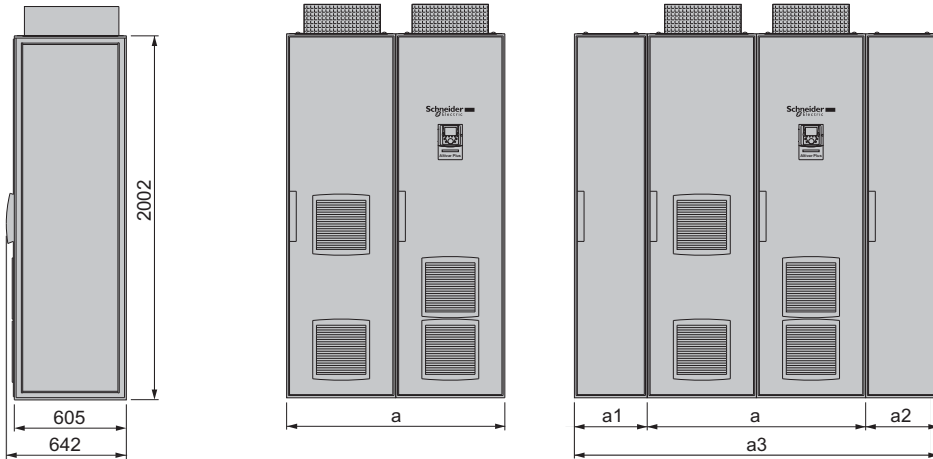

ATV71	Option	a	a1	a2	a3
EXC●C16N4H	With or without general options or options depending on the power	1200	–	–	1200
	Cable entry via the top	1200	400	–	1600
EXC●C20N4H, EXC●C25N4H	With or without general options or options depending on the power	1600	–	–	1600
	Cable entry via the top	1600	400	–	2000
EXC●C31N4H, EXC●C40N4H	With or without general options or options depending on the power	2000	–	–	2000
	Motor choke	2000	–	400	2400
	Cable entry via the top	2000	400	400	2800
	Cable entry via the top + motor choke	2000	400	400	2800
EXC●C50N4H	With or without general options or options depending on the power	2400	–	–	2400
	Motor choke	2400	–	400	3200
	Cable entry via the top	2400	400	400	2800
	Cable entry via the top + motor choke	2400	400	400	3200

Protection degree IP23 / IP54
 Side view Basic device

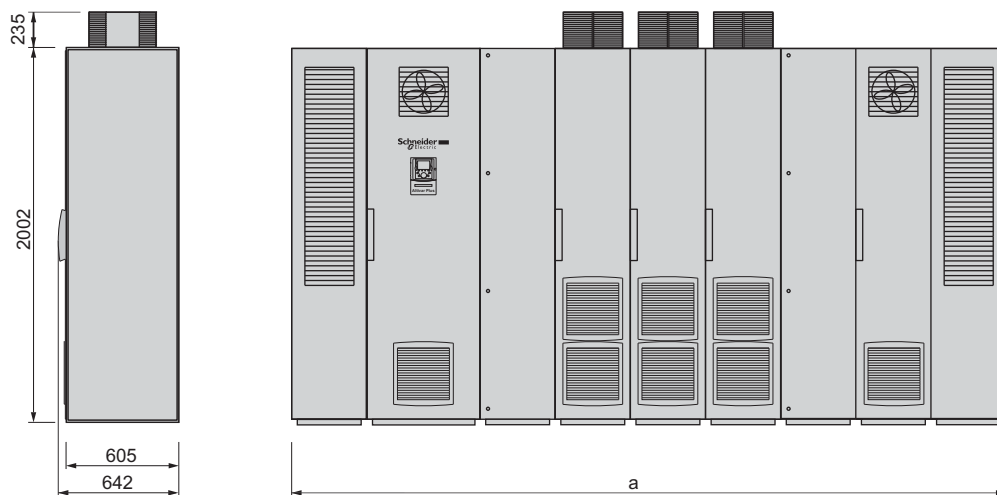

Basic device incl. options

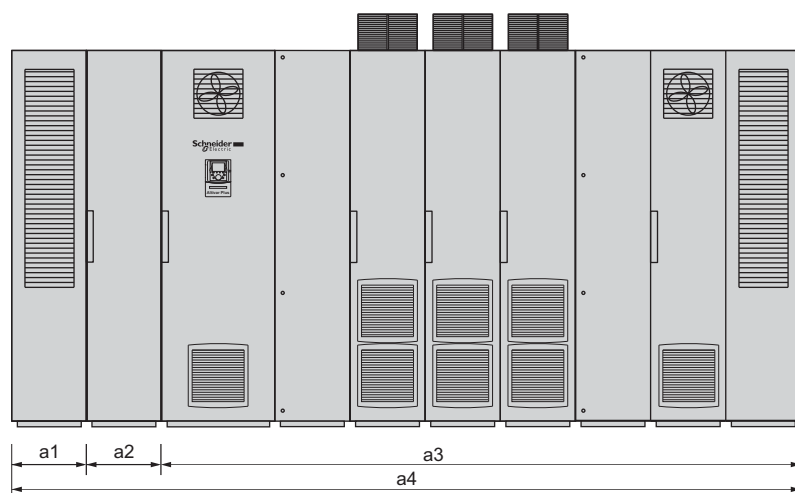

ATV71	Option	a	a1	a2	a3	a4
EVA●C63YH...EVA●M10YH	Without general options or with/without options depending on the power	3800	-	-	-	-
	Cable entry via the top	-	400	400	3400	4200

Protection degree IP23 / IP54
Side view **Basic device**

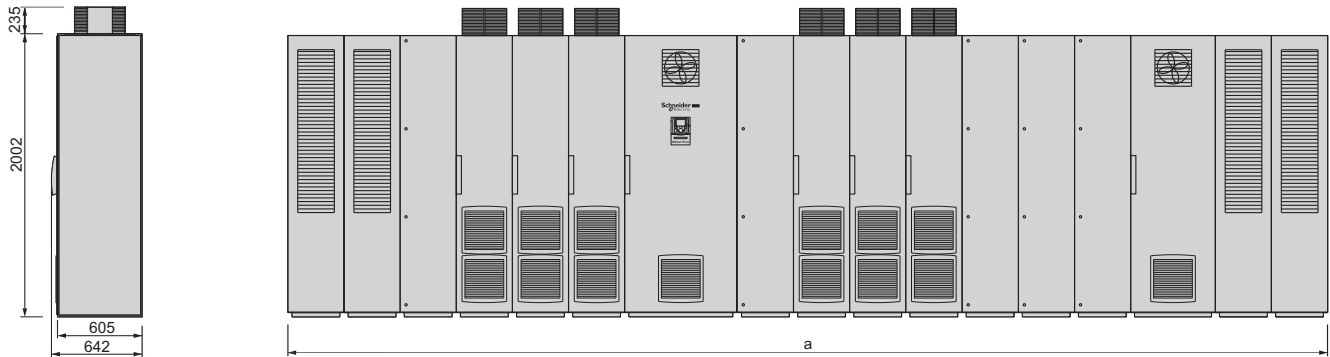

Basic device incl. options

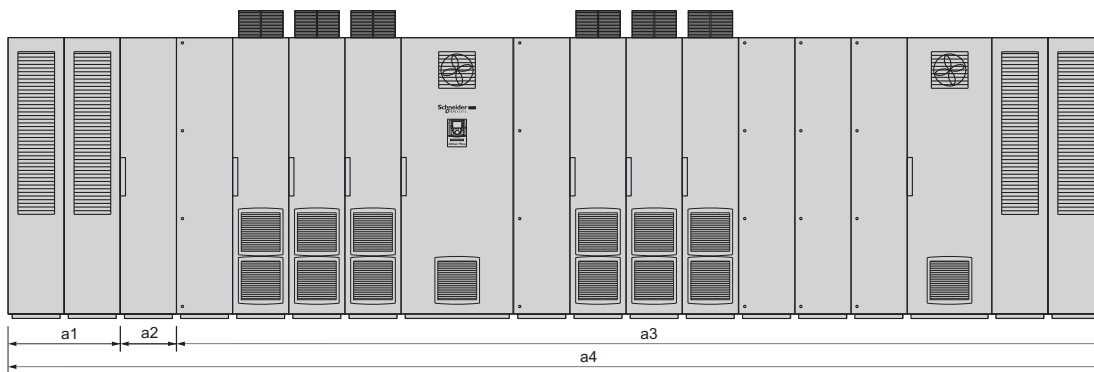

ATV71	Option	a	a1	a2	a3	a4
EXA●M12YH...EXA●M20YH	Without general options or with/without options depending on the power	7400	–	–	–	–
	Cable entry via the top	–	800	400	6600	7800



ROBOTICS > DRIVES > SYSTEMS
EC 13722

WA

22 Beneficial Way Wangara WA 6065 ☎ (08) 6314 1111
✉ support@automation-control.com.au

ABN 87 619 578 595

NSW

Unit 7 / 70 Holbeche Road Arndell Park NSW 2148 ☎ (02) 8078 2288
✉ cs@automation-control.com.au

ABN 61 645 267 116